

# Manual for Streets 2



## Wider Application of the Principles

# Published by the Chartered Institution of Highways & Transportation

Published September 2010

All rights reserved. No part of this publication shall be reproduced, copies stored in an electronic retrieval system or transmitted without the written permission of the publishers.

© CIHT 2010

ISBN 978-0-902933-43-9

## Acknowledgements

The Chartered Institution of Highways & Transportation would like to thank the following people without whom the document would not have been possible.

### Managing Editors:

Alan Young	WSP
Phil Jones	Phil Jones Associates

### Steering Group:

Peter Dickinson	
Louise Duggan	CABE
Wayne Duerden	Department for Transport
Andrew Pearson	Homes and Communities Agency
Daniel Bridger	Communities and Local Government
Anne Locke	English Heritage
Edward Chorlton	ADEPT
Sam Wright	Transport for London
John Smart	CIHT
Amy Naphine	CIHT
Scott Dyball	CIHT

### Contributors:

Steve Proctor	TMS
John Dales	Urban Initiatives
Stuart Reid	MVA Consultancy
Ben Castell	Scott Wilson
Peter Jones	UCL
Paul Forman	
Emily Walsh	Solihull MBC
Bob White	Kent CC
Stephen Hardy	Dorset CC
Tim Pharaoh	
Graham Paul Smith	
Anne Locke	English Heritage
Tim Cuell	WSP
Andrew Cameron	WSP
Nicola Cheetham	Transport for London
Ben Hamilton-Baillie	Hamilton-Baillie Associates

**Proof Reader:**

John Cordwell

**Financial Support:**

Department for Transport, Commission for Architecture and Built Environment, Homes and Communities Agency and Association of Directors of Environment, Economy, Planning and Transport

**Photographs courtesy of:**

Phil Jones, Phil Jones Associates		
Stephen Hardy, Dorset County Council	P11	CABE/Jane Sebire
Tim Pheby, Transport Initiatives	P15(1)	CABE/Jane Sebire
Andrew Cameron, WSP	P15(2)	David John Urban Initiatives
John Dales, Urban Initiatives	P17(1)	Gillespies
Adrian Lord, Arup	P18	CABE
Rob Marshall, Transport Initiatives	P49	CABE/Jane Sebire
John Smart, CIHT	P62(1)	Nottingham City Council
Scott Dyball, CIHT	P62(2)	Nottingham City Council
Deborah Sims, Mott MacDonald,	P62(3)	Nottingham City Council
Brian Johnson, Keep Britain Tidy	P66(3)	Louise Duggan
Ben Hamilton-Baillie, Hamilton-Baillie Associates	P81(1)	Louise Duggan
Transport for London	P81(2)	Camlins
Alan Young, WSP	P81(3)	Louise Duggan
Graham Paul Smith	P87(1)	CABE/Stephen McLaren
David Sprunt, Essex County Council	P88(3)	CABE/Stephen McLaren
Steve Proctor, TMS Consultancy	P97(5)	Southampton City Council
Joe Burns, Mouchel		

CIHT and the members of the Steering Group who produced this document have endeavoured to ensure the accuracy of its contents. However, the guidance and recommendations given should always be received by the reader 'in light of the facts' of their specialist circumstances and specialist advice obtained as necessary. Any references to legislation discussed within this document should be considered in the light of current and any future legislation. No liability for negligence or otherwise in relation to this document and its contents can be accepted by CIHT, the members of the Steering Group, its servants or agents, or the managing editors or contributors.

Published by the Chartered Institution of Highways and Transportation,  
119 Britannia Walk,  
London N1 7JE  
Registered Charity No. 1136896  
Published 2010. ISBN 978-0-902933-43-9

# Contents

	Ministerial Foreword	001
	Presidential Foreword	002
	Partnering Organisations Preface	003
	Status and Application	004
	<b>Section A – Context and Process</b>	<b>005</b>
<b>1</b>	<b>Principles</b>	<b>007</b>
1.1	Introduction	007
1.2	MfS Principles	007
1.3	Scope of MfS	008
1.4	The Benefits of Better Streets	009
<b>2</b>	<b>Networks, Contexts and Street Types</b>	<b>012</b>
2.1	Introduction	012
2.2	Network	014
2.3	Context: Town and City Centres	015
2.4	Context: Urban and Suburban Areas	017
2.5	Context: Urban Extensions	021
2.6	Context: Interchanges	023
2.7	Context: Village Centres	024
2.8	Context: Rural Areas	026
2.9	Context: Urban and rural settlements	027
<b>3</b>	<b>Highway Design, Risk and Liability</b>	<b>029</b>
3.1	The Need for Additional Clarification	029
3.2	Design Guidance and Professional Judgement	030
<b>4</b>	<b>Design and Implementation Process</b>	<b>031</b>
4.1	Introduction	031
4.2	Community involvement	031
4.3	Stages of Improvement	032
4.4	Developing a Quality Audit Process	034
	Kent Design Guide	035
	Quality Audit Process: St Mildred's Tannery Canterbury, Kent	035
4.5	Road Safety Audit	037
4.6	Maintenance Issues	038
	<b>Section B – Detailed Design Issues</b>	<b>041</b>
<b>5</b>	<b>Pedestrian Needs and Footways</b>	<b>043</b>
5.1	Pedestrian Needs	043
5.2	Footway Provision	043
<b>6</b>	<b>Cycle Facilities</b>	<b>045</b>
6.1	Introduction	045
6.2	Cycle Lanes, Cycle Tracks and Markings	045
6.3	Cycle Parking	047
<b>7</b>	<b>Bus Facilities</b>	<b>049</b>
7.1	Introduction	049
7.2	Bus Priority	049
7.3	Bus Stops	049
7.4	Bus Laybys and Boarders	050
<b>8</b>	<b>Carriageways</b>	<b>051</b>
8.1	Introduction	051
8.2	Design Speed	051
8.3	Horizontal Alignment	052
8.4	Carriageway Gradients	052
8.5	Vertical Curvature	053
8.6	Carriageway and lane widths	053

8.7	Refuges, Medians and Central Reservations	054
8.8	Kerbs	055
<b>9</b>	<b>Junctions, Crossings and Accesses</b>	<b>057</b>
9.1	Introduction	057
9.2	Spacing of Junctions	058
9.3	Crossings	058
9.4	Priority and Uncontrolled Junctions	063
9.5	Squares	065
9.6	Conventional Roundabouts	065
9.7	Mini Roundabouts	067
9.8	Traffic Signals	068
9.9	Traffic Management and One Way Systems	070
9.10	Direct Frontage Access	071
<b>10</b>	<b>Visibility</b>	<b>073</b>
10.1	Introduction	073
10.2	Visibility Requirements	075
10.3	Forward Visibility	075
10.4	Visibility at Priority Junctions	076
10.5	X and Y Distances	078
10.6	Visibility Along the Street Edge	079
10.7	Obstacles to Visibility	080
<b>11</b>	<b>On-Street Parking and Servicing</b>	<b>081</b>
<b>12</b>	<b>Street Furniture and Trees</b>	<b>083</b>
12.1	Introduction	083
12.2	Procedures for reducing street furniture	084
12.3	Keeping footways clear	085
12.4	Guardrail	087
12.5	Street Trees and Planting	091
12.6	Street Lighting	093
12.7	Security Measures	094
<b>13</b>	<b>Traffic Signs and Markings</b>	<b>095</b>
13.1	Introduction	095
13.2	Size and mounting height of Signs	095
13.3	Yellow Backing Boards	096
13.4	Keep Left/Right Signs	096
13.5	Centreline Markings	097
13.6	Zig-Zag Markings	098
13.7	Coloured Surfacing	098
13.8	Signs and Markings at Junctions	098
13.9	No-Waiting Markings	099
	<a href="#">Section C – Case Studies</a>	<a href="#">101</a>
<b>14</b>	<b>Case Studies</b>	<b>103</b>
14.1	Walworth Road, Southwark, London	103
14.2	London Road, Southampton	108
14.3	Sheaf Square & Howard Street, Sheffield	113
14.4	High Row & West Row, Darlington, Part of the 'Pedestrian Heart'	119
14.5	Maid Marian Way, Nottingham	124

## Ministerial Foreword



Streets and roads make up around three-quarters of all public space – their design, appearance, and the way they function have a huge impact on the quality of people's lives. The Department for Transport is committed to high quality design in the public realm and our technical advice is evidence of that commitment.

In 2007 the Department published the Manual for Streets, replacing guidance which had been in use for 30 years. It completely changed the approach to the design and provision of residential and other streets. It enjoys an excellent standing and its success has generated a desire among professionals for technical advice to cover other streets and roads along similar lines.

Manual for Streets 2 – Wider Application of the Principles is the result – a product of highly collaborative working between the Department for Transport and industry. It is an excellent demonstration of what can be achieved when Government works in partnership with others.

I congratulate the Chartered Institution of Highways and Transportation and the team which made publication of Manual for Streets 2 possible and I commend the document to all those involved in designing the public realm. The challenge now is for them to embrace the advice and extend the advantages of good design to streets and roads outside residential areas.

A handwritten signature in black ink that reads "Norman Baker". The signature is written in a cursive, slightly slanted style.

**NORMAN BAKER**  
Parliamentary Under Secretary of State  
for Transport

# Presidential Foreword



By Geoff Allister  
CIHT President 2010-2011

In 2007 the Department for Transport published the Manual for Streets, a landmark document that is changing the face of our residential streets. The Manual for Streets (MfS1) did not set out new policy, it reinforced a philosophy that had been growing since the late 1990s to return our residential streets to the community by engineering them to create a greater sense of place, provide an environment that is accessible and safe for all, and one that improves the quality of life.

The Chartered Institution of Highways and Transportation's new guidelines builds on the advice contained in MfS1, exploring in greater detail how and where its key principles can be applied to busier streets and roads in both urban and rural locations up to, but not including, trunk roads. Manual for Streets 2 – Wider Application of the Principles will help to fill the perceived gap in design advice between MfS and the design standards for trunk roads set out in the Design Manual for Roads and Bridges.

Manual for Streets 2 is the result of a partnership between practitioners and policy makers from highway engineers and urban designers to transport planners. The quality of the advice it contains is a true testament to the knowledge and expertise of all those who have contributed to its preparation. I thank them all, particularly the members of the steering group and the editorial team for the considerable time and effort they have contributed to this project.

I would also like to thank the sponsors the Department for Transport, the Association of Directors of Environment, Economy, Planning and Transport, the Commission for Architecture and the Built Environment and the Homes and Communities Agency who have made these guidelines possible.

On behalf of the Institution, I am pleased to commend Manual for Streets 2 – Wider Application of the Principles to all those who are involved in the planning, construction and improvement of our streets and roads. I am sure it will make a significant contribution to professional practice and, over time, to our communities and the places where people live, work and play.

Geoff Allister  
President 2010-2011

A handwritten signature in black ink that reads "G W Allister". The signature is written in a cursive style with a large, stylized 'G' and 'A'.

## Partnering Organisations Preface

Streets play a fundamental part in community life which is why CABE has been a long term supporter of the development of Manual for Streets. Our experience tells us that creative design can deliver more vibrant and inclusive streets. Happily we're not alone in this view. Policy makers, practitioners, and community members also identify well designed, civilising streets as critical to issues such as community cohesion, economic vitality, well-being and health. The key challenge in delivering these wider benefits is the ability to strike a more effective balance between the movement, meeting and exchange functions of our street network. Manual for Streets 2 will play an important role in supporting this agenda.



Richard Simmons  
Chief Executive, CABE

ADEPT enthusiastically supports this important piece of work which will be an essential reference in the future. Local authorities are increasingly aware of the fundamental nature of well designed and maintained streets to the economic, social, educational and environmental well-being of local citizens and communities; and the harmful consequences of neglecting the places where we live and work.



George Batten  
President of ADEPT



# Status and Application

Manual for Streets 2: Wider Application of the Principles (MfS2) forms a companion guide to Manual for Streets (MfS1). Whilst MfS1 focuses on lightly-trafficked residential streets it also states that, *'a street is defined as a highway that has important public realm functions beyond the movement of traffic.... Most highways in built up areas can therefore be considered as streets.'* MfS1 also stated that, *'many of its key principles may be applicable to other types of streets, for example high streets and lightly trafficked lanes in rural areas'*.

MfS2 builds on the guidance contained in MfS1, exploring in greater detail how and where its key principles can be applied to busier streets and non-trunk roads, thus helping to fill the perceived gap in design guidance between MfS1 and the Design Manual for Roads and Bridges (DMRB).

DMRB is the design standard for Trunk Roads and Motorways in England, Scotland, Wales and Northern Ireland. The strict application of DMRB to non-trunk routes is rarely appropriate for highway design in built up areas, regardless of traffic volume.

MfS2 provides advice and does not set out any new policy or legal requirements.

The following definitions apply throughout this document:

MfS1 refers to Manual for Streets (2007).

MfS2 refers to this document.

MfS refers to both documents.

# Section A

## Context and Process



# 1\_ Principles

## 1.1\_ Introduction

**1.1.1** MfS2 has been prepared for the Chartered Institution of Highways and Transportation (CIHT) by a multidisciplinary team of consultants. The document is endorsed by the Department for Transport (DfT), the Homes and Community Agency (HCA), the Welsh Assembly Government (WAG), Commission for Architecture and the Built Environment (CABE), the Association of Directors of Environment, Economy, Planning and Transport (ADEPT) and English Heritage. All of these organisations contributed to its development.

**1.1.2** This new document does not supersede MfS1; rather it explains how the principles of MfS1 can be applied more widely. It draws on a number of sources including:

- The Department for Transport's 'Mixed Priority Route' research study<sup>1</sup>;
- Interim findings from the ongoing Department for Transport research into Shared Space<sup>2</sup>;
- Case Studies, including detailed research by CABE; and
- Further research into the relationship between junction visibility and collisions.

## 1.2\_ MfS Principles

**1.2.1** MfS1 changed the way we approach the design, construction, adoption and maintenance of urban streets. The principal changes to practice, as set out below, also form the basis of this document which considers the wider highway network.

- **Applying a user hierarchy** to the design process with pedestrians at the top. This means considering the needs of pedestrians first when designing, building, retrofitting, maintaining and improving streets.
- **Emphasising a collaborative approach** to the delivery of streets. Many busy streets and rural highways require a 'non-standard' approach to respond to context and this can be achieved by working as a multidisciplinary team and by looking at and researching other similar places that work well. It is important to include all skill sets required to meet scheme objectives. Many of these are included in MfS1, paragraph 1.2.1.
- **Recognising the importance of the community function** of streets as spaces for social interaction. Streets should integrate not segregate communities and neighbourhoods.
- **Promoting an inclusive environment** that recognises the needs of people of all ages and abilities. Designs must recognise the importance of way-finding and legibility, especially with regards to the sensory and cognitive perceptions of children, older people and disabled people.
- **Reflecting and supporting pedestrian and cyclist desire lines** in networks and detailed designs.
- **Developing masterplans and preparing design codes** for larger scale developments, and using design and access statements for all scales of development.
- **Establishing a clear vision and setting objectives for schemes**, which respond to the more complex and competing requirements in mixed use contexts.
- **A locally appropriate balance should be struck between the needs of different user groups.** Traffic capacity will not always be the primary consideration in designing streets and networks.
- **Creating networks of streets that provide permeability and connectivity** to main destinations and choice of routes.
- **Moving away from hierarchies of standard road types** based on traffic flows and/or the number of buildings served.
- **Developing street character types** on a location-specific basis requiring a balance to be struck between place and movement in many of the busier streets.
- **Encouraging innovation** with a flexible approach to street layouts and the use of locally distinctive, durable and maintainable materials.
- **Using quality audit processes** that demonstrate how designs will meet objectives for the locality.
- **Designing to keep vehicle speed at or below 20mph** in streets and places with significant pedestrian



Both of these streets have about the same amount of carriageway space and carry around the same volume of vehicular traffic. The cross section and arrangement of buildings mean that the one in the upper photo segregates two communities whilst the one in the lower photo is at the centre of the community and offers retail and commercial opportunities.

movement unless there are overriding reasons for accepting higher speeds.

- **Using the minimum of highway design features** necessary to make the streets work properly. The starting point for any well designed street is to begin with nothing and then add only what is necessary in practice.

### 1.3\_ Scope of MfS

**1.3.1** The following key areas of advice, derived from principles contained in MfS, can be applied based on speed limits, subject to a more detailed assessment of local context, as shown below in **Table 1.1**.

**1.3.2** It is clear from **Table 1.1** that most MfS advice can be applied to a highway regardless of speed limit. **It is therefore**

streets with on-street parking and direct frontage access to 2/3 lane dual carriageways. Furthermore, local context varies not only from street to street but also along the length of a street.

(See **Figure 1.1**.)

**1.3.6** Where a single carriageway street with on-street parking and direct frontage access is subject to a 40mph speed limit, its place characteristics are more of a residential street or high street, with higher traffic flows, and may result in actual speeds below the limit. It is only where actual speeds are above 40mph for significant periods of the day that DMRB parameters for SSD are recommended. Where speeds are lower, MfS parameters are recommended. Where there may be some doubt as to which guidance to adopt, actual speed measurements should be undertaken

Speed Limit	20mph	30mph	40mph	50+mph
User Hierarchy	●	●	●	●
Team Working	●	●	●	●
Community Function	●	●	●	●
Inclusive Design	●	●	●	●
Ped/Cycle Support	●	●	●	●
Master Plans/Design Codes	●	●	●	●
Stopping Sight Distance	●	●	●	●
Frontage Access	●	●	●	●
Minimise Signs and Street Furniture	●	●	●	●
Quality Audits	●	●	●	●
Connectivity/Permeability	●	●	●	●

**Table 1.1** Application of key areas of MfS advice

**Note:** ● yes ● subject to local context

**recommended that as a starting point for any scheme affecting non-trunk roads, designers should start with MfS.**

**1.3.3** Where designers do refer to DMRB for detailed technical guidance on specific aspects, for example on strategic inter-urban non-trunk roads, it is recommended that they bear in mind the key principles of MfS, and apply DMRB in a way that respects local context. It is further recommended that DMRB or other standards and guidance is only used where the guidance contained in MfS is not sufficient or where particular evidence leads a designer to conclude that MfS is not applicable.

**1.3.4** The application of MfS advice to all 30mph speed limits as a starting point is in keeping with MfS1.

**1.3.5** Much of the research behind MfS1 for stopping sight distance (SSD) is limited to locations with traffic speeds of less than 40mph and there is some concern that driver behaviour may change above this level as the character of the highway changes. However, 40mph speed limits in built-up areas cover a wide range of contexts, from simple urban

to determine which is most appropriate. (See **Chapter 10** for SSD guidance.)

**1.3.7** Similarly, in rural areas many parts of the highway network are subject to the national speed limit but have traffic speeds significantly below 60mph. (See **Figure 1.2**) Again in these situations where speeds are lower than 40mph, MfS SSD parameters are recommended.

**1.3.8** Direct frontage access is common in all urban areas, including where 40mph speed limits apply, without evidence to suggest that this practice is unsafe. This is confirmed in TD41/95<sup>3</sup> (Annex 2 paragraph A2.10) which states that *'in the urban situation there is no direct relationship between access provision and collision occurrence'*. However, this is not true of rural roads (A2.5) where the research identified a *'statistically significant relationship for collisions on rural single carriageways with traffic flow, link length and farm accesses. On rural dual carriageways, the significant relationship extended to laybys, residential accesses and other types of access including petrol filling stations'* (See **Chapter 9** for further advice on direct frontage access.)

**1.3.9** This approach demonstrates that the key MfS principles can be applied widely to improve the quality of highways and their application is not limited to low speed or lightly trafficked routes.

**1.3.10** Any new design has to take account of local context, however adopting speed limits as a proxy to identify which elements of MfS apply provides a reasonable way forward. It is clear from **Table 1.1** that for a particular context, even though some aspects of MfS may not apply, there are still many principles which affect design quality that do.



**Figure 1.2** National speed limits apply in rural lanes but actual speeds can be much lower

## 1.4\_ The Benefits of Better Streets

**1.4.1** It is important to take into account multiple objectives when developing transport strategies and schemes, and not simply congestion reduction. These other priorities include economic regeneration, climate change, casualty reduction, reducing air and noise pollution, minimising the impact of transport on the natural environment, heritage and landscaping, and encouraging more sustainable and healthy patterns of travel behaviour.

**1.4.2** Making appropriate provision for road-based public transport, cycling and walking can help to encourage modal shift from the private car, and so contribute to the sustainability and health agendas. Enhancing street environments through a high quality public realm incorporating local materials and historic street features, removal of clutter and pedestrian barriers, use of shared space where appropriate and enhanced street lighting can help to stimulate local economic activity, reduce street crime and encourage a sense of local community; this in turn encourages more local, shorter distance travel on foot or by cycle. This will be particularly important in conservation areas, national parks, World Heritage sites and other environmentally sensitive areas.

**1.4.3** Local Transport Note 3/08, 'Mixed Priority Routes: Practitioners' Guide'<sup>1</sup>, refers to ten schemes which were among the least safe of urban roads which were transformed into safer, friendlier, more attractive and inclusive streets as discussed in the box out below.

Single Lane,  
Frontage Access,  
On-Street Parking



Wide Single Lane,  
Frontage Access,  
On-Street Parking



2/3 Lane Dual  
Carriageway. No  
frontage access.  
No stopping.



**Figure 1.1** Typical Range of Urban 40mph Speed Limits

**The ten MPR schemes:**

- 1 Walworth Road, London
- 2 Wandsworth Road, London
- 3 Prince of Wales Road, Norwich
- 4 Newland Avenue, Hull
- 5 Nantwich Road, Crewe
- 6 Renshaw Street/ Berry Street, Liverpool
- 7 Wilmslow Road, Rusholme, Manchester
- 8 St Peter's Street/ Chequer Street, St Albans
- 9 The Parade/ Victoria Terrace, Leamington Spa
- 10 Cowley Road, Oxford

**Mixed Priority Routes (MPR) demonstration project**

Mixed Priority Routes are streets that carry high levels of traffic and also have:

- A mix of residential use and commercial frontages;
- A mix of road users, i.e. shoppers, cyclists, bus passengers, schoolchildren;
- A mix of parking and deliveries.

They are not just transport routes. Although dealing with transport and safety is a key element, other concerns associated with the local economy and local communities may also generate an interest in improving the area with economic regeneration and environmental improvements.

There are many benefits to be gained from enhancing the high street environment with an integrated approach. The investment is likely to contribute towards assisting the delivery of a range of local authority corporate objectives and targets including:

- Accessibility planning;
- Casualty reduction;
- Economic regeneration;
- Public service agreement;
- Quality of life; and
- Sustainability.

**Outcomes**

Early results across a number of different indicators show that all of the MPR demonstration schemes have been successful in meeting their stated objectives:

- Safety: all schemes have achieved a substantial casualty reduction of between 24% and 60%;
- Environment: noise and air quality measurements have shown improvements;
- Accessibility: pedestrian and cycling activity has increased, and children and mobility impaired users generally feel more confident; and
- Economy: improvements in the quality of streetscape have led to a reduction in vacant premises and a more vibrant local economy.



Prince of Wales Road, Norwich



Newland Avenue, Hull

**1.4.7** Green infrastructure, which provides a network of living green spaces, is important to the design of urban communities. Trees are one of the most visible components of green infrastructure and highway engineers and transport planners are well placed to help deliver this element of the natural environment. In the last few years a growing body of research has made it clear that trees bring a wide range of benefits both to the urban environment, individual people and to society as a whole. Further guidance on how to plan and design for street trees is given in **Chapter 12**.

**1.4.8** A number of case studies that demonstrate the value of improving the public realm can be found in Section C.

**1.4.4** These schemes have clearly demonstrated a range of benefits beyond just road safety. These include increased economic vitality due to additional visitors to local shops and services and increased investment in regeneration, through improvements in facilities and the environment.

**1.4.5** Research into mixed-use high streets carried out by University of Westminster<sup>4</sup> has shown that they are well used and well liked by local people and encourage sustainable and inclusive patterns of living. Resolving the challenges of balancing the movement and place functions will result in these streets becoming the cornerstone of sustainable communities.

**1.4.6** Both sets of research complement the studies carried out by CABE which found a clear link between street quality and property values - see Example below.

This work identified for the first time a direct causal link between street quality and market prices, which discounted all other factors. It established that prices are not totally explained by factors such as prosperity or the neighbourhood or public transport accessibility alone; a significant proportion of these prices are explained solely by the quality of the street.



**CABE: Paved with Gold: the Real Value of Good Street Design (2007)**<sup>5</sup>

Streets are public assets and, in common with other public realm features, assessing their value is a difficult undertaking. Broadly speaking streets are too often viewed in purely technical terms by the people designing and managing them on the one hand and their more aesthetic qualities by people funding economic redevelopment work on the other.

The truth lies somewhere in between - that streets which resolve competing demands and create places that people enjoy using can deliver in transport economic and social terms. CABE's research, 'Paved with Gold: the Real Value of Good Street Design' (2007), was designed as a demonstration project to show how to measure the impact of street design improvements on market prices as revealed through retail rents and residential prices.

London High Street case studies, outside the centre to avoid tourist effects, were identified in order to make them as comparable as possible. Streets with large shopping centres were excluded as their presence would skew results. A range of types of area and quality of streets was identified.



## 2\_ Networks, Contexts and Street Types

### 2.1\_ Introduction

**2.1.1** This section examines some common street types in different contexts to demonstrate how context and user needs inform a balanced approach to design, see **Figure 2.1**. It provides general advice on the application of the key MfS principles in **Section 1.2**. While the examples are not meant to be exhaustive, they will serve as a guide to other situations.



Figure 2.1: Changing Street Context

**2.1.2** In **Figure 2.1**, the Movement function remains largely the same along the route, but the Place function varies according to the importance of that part of the street as a place and the predominant type of land use. As the Place function becomes more important, the relative weight given to the Movement function will be reduced when deciding on priorities and an appropriate street design.

**2.1.4** A more formal approach to the determination of status level is given in the 'Link and Place' methodology<sup>6</sup>, which provides definitions for different status levels, resulting in a 'matrix' of street types varying in their balance of Link and Place status, as shown in **Figure 2.3**. (In MfS, the term 'movement' is used rather than 'link', but the principle is the same.)



**Figure 2.2**

**2.1.3** The balance between Place and Movement at any particular location can be expressed using the hierarchy diagram shown in **Figure 2.2**. A high street, for example, has both a relatively high Movement and Place status level.

**2.1.5** A matrix similar to this has been used by the London Borough of Hounslow<sup>7</sup> to classify its entire street network into segments corresponding to the 25 cells in the matrix, while Transport for London has used a 2x6 matrix (i.e. two levels of Link and six levels of Place) for its categorisation of the 580km Transport for London Road Network.

**2.1.6** The application of the movement/place diagram **Figure 2.2** does not depend on the detailed analytical

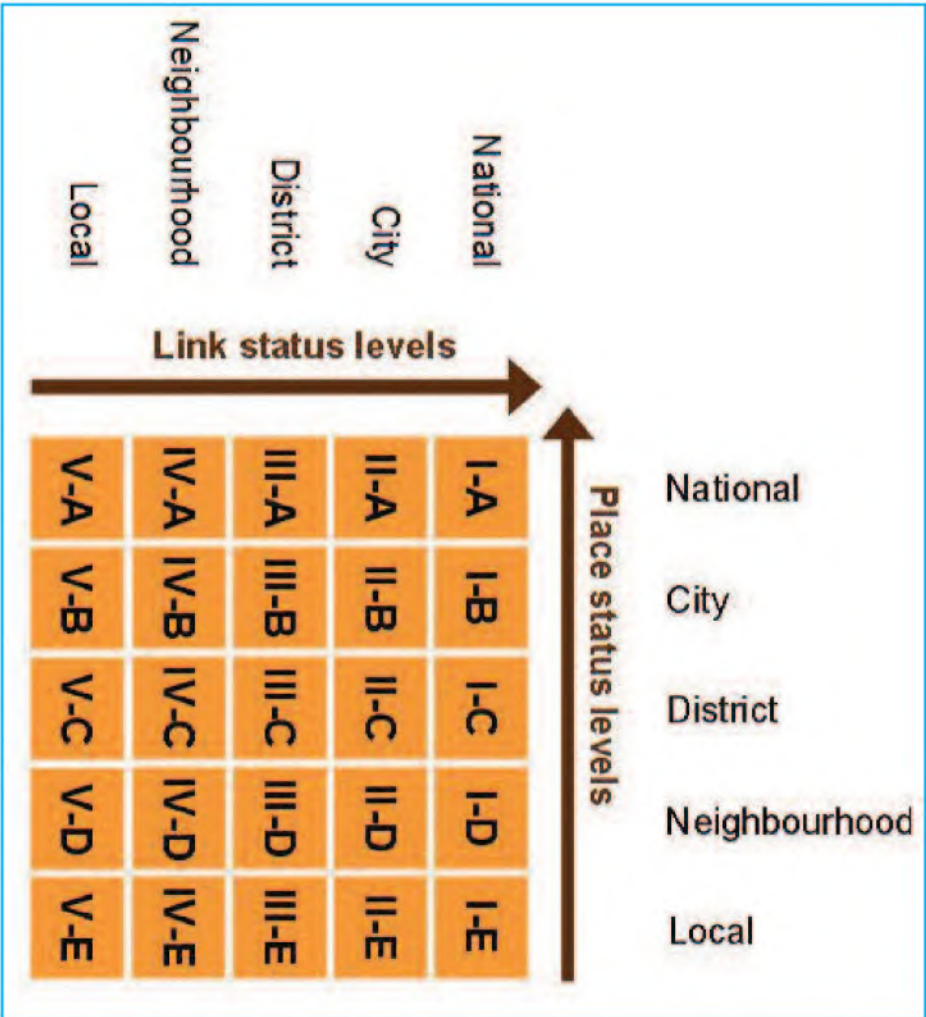

Figure 2.3: The Hierarchy Matrix from 'Link and Place'

approach as indicated in **Figure 2.3**. It can simply be used as a design philosophy that ensures a balanced approach is taken. Further advice on understanding the character of a place is given in *Understanding Place: An Introduction and Associated Guidance on Historic Area Assessments*<sup>9</sup>.

### 2.2\_ Network

**2.2.1** Highway networks interlace and connect residential, commercial, urban and suburban areas of cities, towns and villages. They fulfill many functions along their routes catering for many types of journey by different modes.

Their interrelated nature means that changes to one part of the network can have implications for adjacent routes and therefore must be understood and taken into account when designing and implementing highway improvements.

**2.2.2** Major routes in the highway network are most commonly classified by the volume of traffic they carry and are often known as Principal Routes, Distributor Roads, Ring Roads, or similar. These standard classifications remain constant for the whole route and this has often been used to inform the design and management criteria that are applied to different parts of the network. However, by failing to take account of the changing context along the route this classification system limits understanding of how improvements or maintenance should reflect the wider functions such routes serve.

## 2.3\_ Context – Town and City Centres

**2.3.1** Town and city centres are often the most important urban environments, forming a focus for economic vitality, public life and image of the town/city as a whole. They are where most exchange takes place, be it commercial, social, cultural or political. They are also likely to be the public places where people spend more time outdoors than anywhere else in the town/city, including parks and other green spaces.

**2.3.2** Centres are the places that most people in a town or city are travelling to and from: they are at the heart of the local highway, bus and cycle networks; they will contain, or usually be close to, the main railway station and main bus station/hub; and they will experience far greater footfall than any other part of the urban area. They are, in themselves, transport interchanges.

**2.3.3** A town or city's public image is shaped by the quality of its public realm. The beauty, safety and state of repair of its streets and spaces are very important to its success.



Walworth Road, London



Darlington

## Common Street Types: Multifunctional Streets and Spaces

### Typical Characteristics

**2.3.4** Town and city centres are made up of a network of connected multifunctional streets and spaces, which in larger centres may historically have made up a series of distinct 'quarters' with different character and functions. Over the latter part of the 20th century, many centres became more uniformly focussed on retail. While centres may thrive during shopping hours, many are 'dead' once the shops shut.

### Movement and Place Functions

**2.3.5** Town and city centres should be, pre-eminently, places. However, many have been harmed either by attempts to protect their place status through eliminating some of the movement activity that made them the places they were, or by an emphasis on enabling traffic to get across them as easily as possible.

**2.3.6** Centres should be the most walkable part of the network; they should accommodate public transport services, cycle routes and cycle parking, while remaining accessible by private car. As centres of public life, they must actively enable access by all in society, and they must also support efficient access by delivery, service and emergency vehicles. At the same time, they should be attractive places to shop, eat, drink, work, play, do business, meet, study, hang around in and look at.

**2.3.7** There is barely a single movement or place function that a town/city centre may not need to accommodate, all of which represents a very considerable challenge to designers of streets, spaces and the broader public realm. But it is a challenge that must be met if urban life is to flourish.

### Key Issues

**2.3.8** Centres that have successfully balanced movement and place functions have done so by prioritising pedestrian and cycle movement within the core, while making it straightforward to get to the edge of the centre by other modes. This means that busier routes around the town centre must be easily crossed by pedestrians and cyclists and should not form a barrier.



Breaking the Concrete Collar In Birmingham

In Birmingham the Inner Ring Road was long seen as a constraint to extending the City's inner retail core and was a major barrier to pedestrians. This has now been broken with at-grade crossings provided for pedestrians who previously had to contend with detours via unpleasant subways. Elsewhere in Birmingham the Inner Ring Road has been lowered with a ground level pedestrian route provided in place of subways between the City Centre and Broad Street, helping to regenerate this area of the City.

**2.3.9** Access restrictions by day and/or time of day may be appropriate in core areas. This means that the physical layout should cater for a number of patterns of use, rather than just one: for example, streets having a conventional carriageway and footway layout with a substantial kerb upstand between may be well suited for typical longitudinal movements by vehicles and pedestrians, but cause problems where many crossing movements take place or the space is being used for events, such as a street market.

**2.3.10** Long-term adaptability should be a design principle for town and city streets. This can be achieved by adopting an area-wide public realm strategy and a streetscape manual to ensure that an harmonious public realm is achieved through consistent design choices, which the local authority is able to maintain to a high standard.

**2.3.11** Where there are proposals to introduce vehicle restricted or pedestrianised areas, the starting position should be that cyclists are allowed to continue to use the streets concerned. If there are concerns about conflict between cyclists and pedestrians, the preferred approach is to allow cycling from the outset on the basis of an experimental traffic regulation order and only restrict access when and if the need has been demonstrated. If restrictions on cycling are shown to be necessary, they may only be required at certain times of day. The restriction periods can always be extended later if the need arises.

**2.3.12** Advice on this issue is set out in TAL 9/93 'Cycling in Pedestrian Areas'<sup>10</sup>. This emphasises that, on the basis of research, there are no real factors to justify excluding cyclists from pedestrianised areas and that cycling can be widely permitted without detriment to pedestrians. This was confirmed by TRL report 583 'Cycling in Vehicle Restricted Areas' (2003)<sup>11</sup> which established that cyclists alter their behaviour according to the density of pedestrian traffic by modifying their speed or dismounting. Case studies contained within the report demonstrate that very few collisions actually occur between cyclists and pedestrians. It also showed that as pedestrian flows rise, the incidence of cyclists choosing to push their cycle also rises and those cyclists who continue to ride tend to do so at a lower speed.

**2.3.13** The TRL research found that within pedestrianised areas most cyclists and pedestrians favour a marked cycle route. However, such a solution should be approached with caution as it can lead to higher cycle speeds and possibly more serious conflicts. Cyclists are also more likely to be obstructed by straying pedestrians using the defined cycle route and this can itself cause conflict.



Darlington



Birmingham

## 2.4\_ Context – Urban and Suburban Areas

**2.4.1** Town and city centres are surrounded by urban and suburban areas, the former being a mix of residential, employment and retail and the latter predominantly residential. Urban areas tend to be higher density and older development.

2.4.2 Suburban areas can be considered the urban extensions of yesterday and tend to be either fully interconnected with the surrounding area, a characteristic of pre World War II development, or less integrated, cul-de-sac development of the post WWII era. Interconnected suburbs are linked together by a network of residential and arterial routes which double as local high streets at certain points. Cul-de-sac suburbs are connected to the outside world by movement-focused distributor roads, relief roads and the arterial network. As noted in MfS1 this type of layout encourages movement to and from an area by car rather than other modes. English Heritage guidance on managing change and conserving the character of historic suburbs is set out in 'Suburbs and the Historic Environment'<sup>12</sup>.

## Common Street Types: Arterial Routes and High Streets

### Typical Characteristics

**2.4.3** Arterial routes form essential parts of the wider highway network acting as key links between towns, cities and local centres. They are usually a part of the core network for the town or city where it is not easy or appropriate to remove or redirect traffic, including HGVs and buses. The level of activity along these links varies depending on location. Along some sections of arterial routes the movement function will be most important; arterial routes are key to the functioning and economy of urban areas. However, along other sections of the routes the place function should be given greater weight.

**2.4.4** Local high streets in interconnected urban and suburban locations often occur along arterial routes where they benefit from through traffic and proximity to adjacent neighbourhoods. In smaller towns and larger villages, high streets may also form the core of the settlement with little scope for removing through traffic. High streets will have a significant element of retail and commercial uses, often mixed with residential use that generates regular, high volume short-stay visits.

**2.4.5** There are significant levels of pedestrian and cycle activity associated with the movement of people along the street and to local destinations. There are also high levels of kerbside activity generated by parking, loading and public transport. Provision for passing trade should take account of the needs of people travelling by all modes.

**2.4.6** Essentially these streets are 'living' streets that act as both a significant local destination and as a corridor for movement through urban and suburban areas or into city, town or large village centres.



A207 Welling, Kent

- fixed building lines;
- extensive statutory undertakers' equipment;
- shallow services;
- established balance of priority to motor vehicles creating difficulties for the reallocation of space due to wider area impacts;
- high cost of remodelling the street;
- demand for parking not in keeping with the physical space available;
- public aspiration in terms of the quality of the finish; and
- maintaining service access.

## Key Issues

**2.4.8** In the main, designers will be tackling problems in high streets that already exist. These streets will therefore frequently have significant and widespread physical constraints:

Kinver High Street, Staffordshire



**2.4.7** High streets (and high street sections of arterial routes) are complex. They often cater for local retail, leisure and social needs as well as passing trade. High Streets can be centres of civic pride where important civic buildings, monuments and spaces are located. These functions need to be understood and incorporated in any redesign

## Movement and Place Functions

Nottingham



**2.4.9** With these complex and competing demands, balancing the place and movement function is challenging and can only be resolved by taking a comprehensive and multidisciplinary approach to solutions that respect local context and user needs.

**2.4.10** On larger new-build schemes it will often be appropriate to build new mixed-use high streets forming an active core to new communities and connecting them to the wider area. In the recent past distributor routes have taken traffic around the edge of a development. Taking this traffic through the centre will make the new high street an accessible, inclusive and active place.

## Common Street Types: Relief Road/Ring Road

### Typical Characteristics

**2.4.11** The terms 'Relief Road' and 'Ring Road' are generally used to describe major roads whose primary function is to carry traffic around an urban centre. While 'Ring Road' implies the existence of a complete loop, the term is also applied to partial loops. 'Relief Roads' tend to be more linear in form.

**2.4.12** Segregation of different user groups is the design philosophy which most clearly characterises Relief/Ring Roads. Another key characteristic is that many were built all or in part, as new highways. While some may have been based on the alignment of existing highways, a significant amount of new construction was involved in turning them into the higher capacity traffic routes. Typically Relief/Ring Roads involved the loss of a significant amount of the existing urban fabric, and the alignment of the new highways were and remain at odds with the historic street structure of the area.

Birmingham Middle Ring Road



**2.4.13** Relief/Ring Roads are typically multi-lane dual carriageways, often with speed limits of 40 or 50mph, with very little frontage development. Typical adjacent land uses are those that welcome excellent highway accessibility yet are not sensitive to the built environment quality (e.g. retail warehousing and other industrial uses) and/or to the backs of buildings whose fronts face inwards to the central streets from which traffic was diverted onto the Ring Road.

## Movement and Place Functions

**2.4.14** Relief/Ring Roads are predominantly about motor traffic movement and hardly at all about place, despite the fact that they are often on the edge of very active town centres. Many new routes were built without footways or provision for cycling despite their urban environment. They are likely to sever communities and disrupt pedestrian and cycle movement to town centres. Where they have been formed from existing streets, the previous place qualities have usually been given little thought and consequently have been considerably damaged.

### Stourbridge Ring Road

Constructed in the 1960s, Stourbridge Ring Road creates a tight collar around the town's compact centre. Formed partly from existing roads and partly on new alignments, it is one-way and encourages high traffic speeds.



The Ring Road did not respect the existing urban form and exposes the rear of a number of historic buildings along the town's High Street. Many sections of the road are not well overlooked by buildings. It forms a barrier to pedestrians, with few at-grade crossings and is very intimidating for cyclists.



## Key Issues

**2.4.15** Where the roads are adversely constraining the development, growth and prosperity of the town/city, then consideration should be given to redressing the balance of movement and place. The scale of change required to transform Relief/Ring Roads from corridors for general traffic to balanced streets has major cost implications. Nevertheless, there are a small but growing number of examples where all or part of the ring road has been remodelled, e.g. Ashford, Nottingham, and Birmingham.

**2.4.16** Some authorities have recognised that a piecemeal approach is all that can be achieved, and have therefore focused on improvements such as the replacement of poor quality subways by at-grade pedestrian crossings, introducing 'friction' features such as kerbside parking and loading bays, moving from one-way to two-way operation, reducing speed limits (with or without the addition of speed-limiting engineering elements), or measures to 'humanise' the roads such as simple decluttering or the widening and planting on median strips.

### Sky Blue Way/Far Gosford Street, Coventry

Sky Blue Way is a major urban relief road, constructed in the 1980s, which relieved traffic from Far Gosford Street, a medieval street on the edge of the city centre. The road carved a broad swathe through the urban fabric, revealing the rear of buildings. There are few buildings overlooking the new route and it is a hostile environment for pedestrians and cyclists.



A scheme has now been developed by the City Council, working with developer partners, to heal the damage done by the road scheme. It introduces new buildings to front onto Sky Blue Way, making best use of the awkward plots of land. Changes to one of the terminal junctions are also proposed, simplifying the layout and removing extensive lengths of guardrailling.

## Common Street Type: Boulevards

### Typical Characteristics

**2.4.17** Boulevards typically carry large volumes of traffic. 'The Boulevard Book'<sup>13</sup> describes three types of boulevard design: (a) streets with a wide central landscaped median, flanked on both sides by carriageways and footways; (b) a wider-than-usual street of conventional layout, with a central carriageway and broad, tree-lined footways (often also referred to as an 'avenue'); and (c) 'multiway boulevards' with a central carriageway for through traffic, tree-lined medians to each side, one-way access carriageways, beyond these medians, and then footways.

**2.4.18** Boulevards are important in many countries. In Britain boulevards have not had such a large part to play in our towns and cities, but there are some UK streets that genuinely justify being defined in this way. London's Park Lane and Cheltenham's Promenade could qualify as could some interwar suburban development which adapted the boulevard typology to facilitate strategic and local traffic movements.



Promenade, Cheltenham

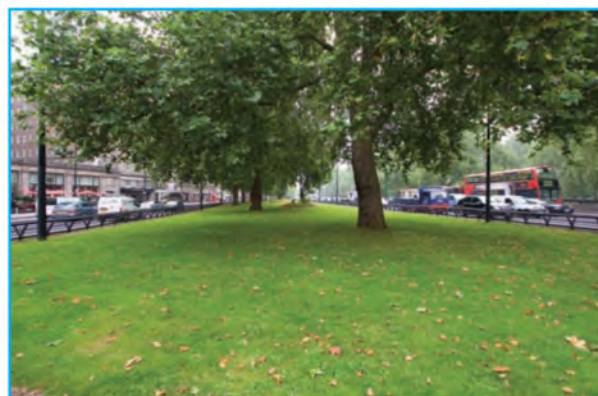

Park Lane, London

**2.4.19** The boulevard typology can be highly appropriate for application to the conversion of some of the nation's widest urban roads from traffic-dominated corridors having no grandeur and a very poor public realm to much more multifunctional urban streets.

### Movement and Place Functions

**2.4.20** Multiple movement functions mixed with a very strong sense of place are at the heart of the boulevard typology.

**2.4.21** Adjacent uses may be of almost any variety: retail, residential, civic, commercial, or a mix. However the grand sense of scale created by the wide street is also a vital place element in its own right. Wide, tree-lined footways are there for the convenience of pedestrians, and there may also be additional leisure space on the medians.

## 2.5\_ Context - Urban Extensions

**2.5.1** An urban extension is the significant growth of an existing town or city with development that ideally is well connected to, and adjacent to, the urban edge of the existing settlement. Urban extensions can provide important 'green infrastructure' links that connect urban open spaces with rural areas.

**2.5.2** They should allow for the growth of our existing towns and cities to take place in a more sustainable way so that new residents and workers in the urban extension can benefit from the existing facilities in the town or city as well as those provided in the extension area. Practice that relies on limited access via distributor and relief roads limits the level of connectivity that can be delivered and is not recommended.

### Common Street Types: High Streets, Residential Streets

#### Typical Characteristics

**2.5.3** Many existing suburban areas are edged with cul-de-sac and low density development, which makes it very difficult to continue the growth of the settlement in a well-connected way particularly by public transport.

**2.5.4** In order to achieve connected growth, urban extensions should link in to the surrounding network of local and strategic routes. Developments with only one or two means of access should be avoided as they segregate existing and new development, and do not provide for good walking and cycling connections.

**2.5.5** The form of the urban extension should be made up of connected streets and urban blocks. The streets should be generally low speed and all, be well overlooked. There should also be a high quality, high frequency public transport system at the heart of the development. The walkable neighbourhood principle should be used to help structure the urban extension.

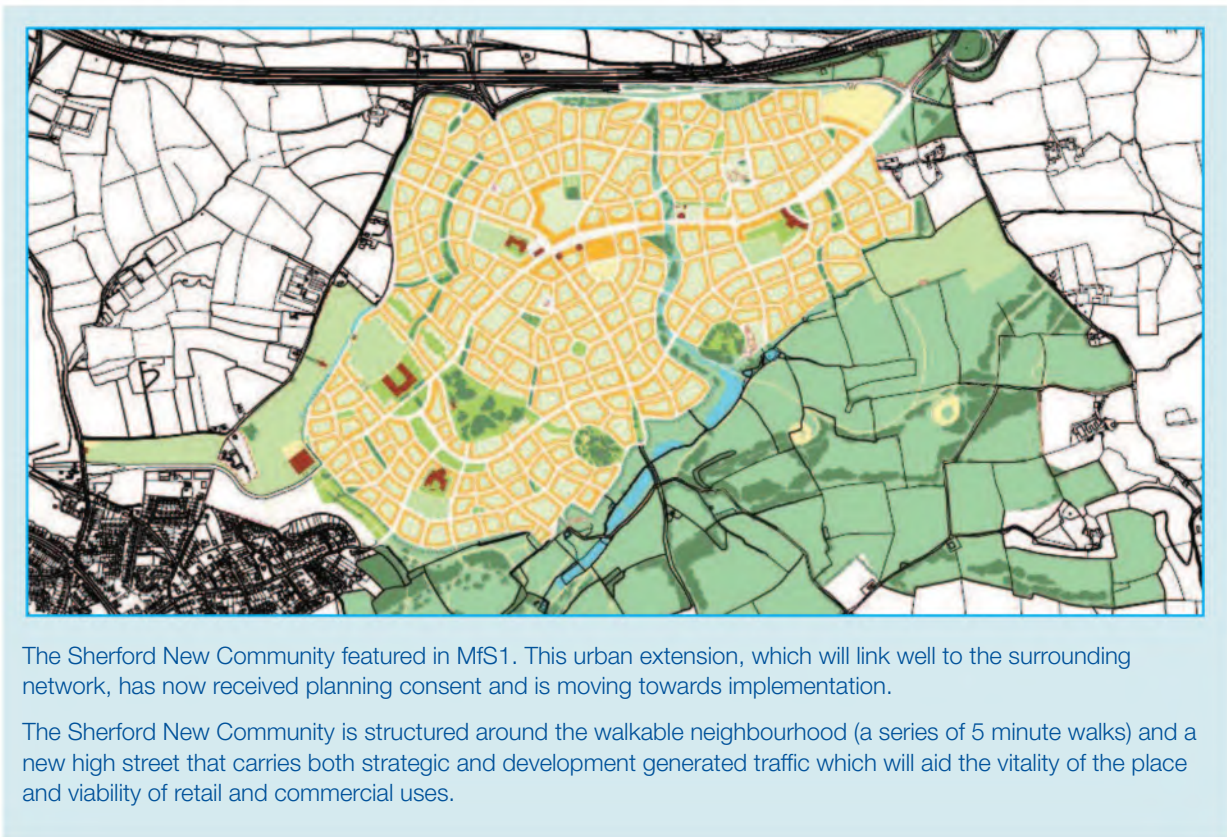

### Movement and place functions

2.5.6 These will vary within an urban extension due to the variation in contexts from high streets to residential streets and squares to mews and courts. However, with all of these street types the consideration of place and the need to integrate communities must underpin design decisions.

### Key Issues

2.5.7 Unfortunately many urban extensions have left unchanged strategic highway routes that run adjacent to or through the development rather than making it a focus for the development, possibly in the form of a high street.

2.5.8 Figure 2.4 illustrates development that ignores, and often backs onto existing highways, and provides few direct connections. The alternative on the right, illustrates how new development which embraces and connects with these routes, changing the form of them to reduce speed and make them more humane can help to deliver integrated growth.

2.5.9 Masterplans for urban extensions should also consider future growth and how the plan could develop further, over say a 50 or 100 year vision. Planning and highway authorities should require developers to provide future connections when further expansion is a possibility.

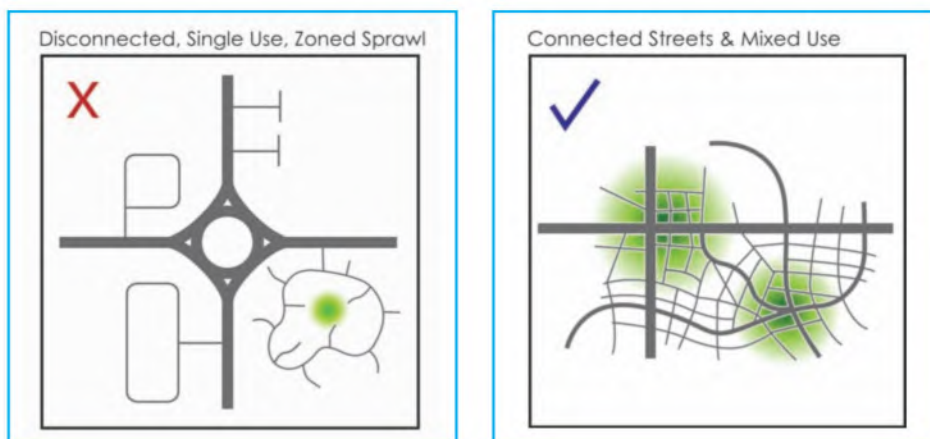

Figure 2.4 - Urban Extensions; Suburban Sprawl vs Connected Development

**2.5.10** Taking this approach will mean that planning and highway authorities will have to accept that the character of rural routes will have to change fundamentally in these locations as they become part of the urban fabric. Local Development Frameworks or in Wales, Local Development Plans can stipulate that developers require sufficient land for adequate connections from new development to potential further expansion.

**2.5.11** Existing routes that pass or run through urban extensions will change in character as development takes place bringing new place function as well as an increase in movement along and across the highway. Both need to be considered in the redesign of the route.

## 2.6\_ Context - Interchanges

**2.6.1** Whilst at one level interchange facilities can comprise major bus, tram and rail stations, at another they could simply refer to a high street or crossroads where two bus routes meet. Both extremes need to be carefully designed to cater for ease of pedestrian movement.

**2.6.2** The need to provide integrated transport to enable different modes of transport to be used in a seamless manner to enable door-to-door travel is crucial. In particular the provision of adequate cycle parking at stations and bus stops can make a public transport journey a convenient and speedy choice.

**2.6.3** Often an interchange is a traveller's first experience of a place, the gateway to a country or city. It will need to encapsulate a sense of arrival appropriate to its scale and location.

**2.6.4** Transport integration covers not just the interchange facility but ticketing and the provision of passenger information. Ultimately, maximising passenger satisfaction, or user experience, is crucial to making public transport more attractive. The aim is to achieve:

- Seamless and efficient movement of pedestrians, cyclists and public transport;
- Increased pedestrian and cyclist satisfaction by making interchanges and their urban context more integrated and attractive to use;
- Improved good quality of information, cycle parking and wayfinding;
- Places that feel and are safe and secure.

### Typical characteristics

**2.6.5** An independent review on how to improve stations<sup>14</sup> recommended that, in the context of street design, improvements to station access should focus on providing a minimum level of provision dependent on the category of the interchange. Features should include:



Louth, Lincolnshire. A bus station that complements the town centre.

- Level access, particularly given the expected concentration of encumbered users in and around transport facilities;
- Clear and concise identification of transport facilities;
- Street direction signs, including cycle/pedestrian routes;
- The provision of cycle access, including secure storage and cycle hub facilities at the station with the development of convenient cycle routes;
- Improved bus access through closer partnerships with train operating companies, local authorities and bus operators; and
- Provision for taxis.

## Movement and Place Functions

**2.6.6** Any strategy to harmonise and integrate the design and function of streets and interchanges will have to work in conjunction with the physical layout of each place and under a range of operating environments.

**2.6.7** Above all, any strategy aimed at enhancing transport integration will have to ensure that pedestrians and cyclists can be catered for and directed in a convenient manner. Success will be dependent upon co-ordination across a range of transport planning, management and operation disciplines.

**2.6.8** The Pedestrian Environment Review Software (PERS)<sup>15</sup> is a well-established approach for auditing pedestrian networks and is recommended in several publications, including Transport for London's (TfL's) guidance 'Walking Good Practice' published in 2010<sup>16</sup>.

**2.6.9** One of the street audit frameworks developed in the PERS system is specifically concerned with Interchange Spaces. This was developed at the instigation of TfL and particularly recognises the specific requirements and challenges of designing public spaces in which interchange is the primary, or most significant, function. This prompts assessment of key elements of an interchange space such as the ability of people to orientate and navigate in the space or to move freely and safely.

## 2.7\_ Context - Village Centres



Troutbeck, Cumbria

**2.7.1** Villages are smaller isolated settlements in rural locations, and can vary from a scattering of dwellings to what could also be described as a small town.

**2.7.2** Villages are the most numerous type of settlement in the UK. In 2001 there were over 4,200 settlements in England with more than 100 residents, and of these some 3,100 had fewer than 5,000 residents. While the majority of people reside in larger settlements, a total of 9.8 million people lived in rural England in November 2009<sup>17</sup>.

**2.7.3** The quality of the built environment in these settlements is obviously important to those who live there, but villages are also an essential part of the make-up of the UK and are vital to its image. Tourism is a major contributor to the rural economy and preserving the attractiveness of village centres is essential if this is to be maintained.



Abbotsbury, Dorset

## Common Street Type: Village Streets

### Typical Characteristics

**2.7.4** Many villages have existed for centuries and are likely to have an historic centre with a street pattern that is unlikely to conform to a standardised highway layout but which it is desirable to conserve in the interests of maintaining the character of the area. Carriageways are often narrow, and footways may be narrow or non-existent and as a result speeds can be low. Street lighting may be below normal standards and may be entirely absent as a conscious decision of the local authorities.

### Movement and Place Functions

**2.7.5** Many historic buildings do not have off-street parking leading to significant demand for on-street parking in many village centres. This can be in conflict with movement functions, particularly where villages are on major routes. As in other situations, an appropriate balance needs to be struck between demand for on-street parking, road safety and visual amenity.

**2.7.6** Village centres have all of the place functions of the centres of larger settlements, albeit on a smaller scale. Most centres will have some shops and one or more pubs, churches and community halls, and so the most important buildings will be located there. Village greens, ponds and other areas of open space will often form a key element within the centre, contributing to the sense of place. The relationship between these buildings, green spaces and the routes through a village is often a major part of its character.



Hallow Village Green, Worcestershire

**2.7.7** Public transport is often limited in rural areas, but services will almost always stop in the village centre. With many villages being compact in size, the centre will be accessible to local residents on foot, and so the number of people on foot will be higher in the centre than in other parts of the settlement.

**2.7.8** In movement terms, many village centres are the focus for street networks that carry low volumes of traffic, but there are also many that are on the route of one or more heavily trafficked highways, including trunk roads. In these cases there are often significant tensions between the movement function of these principal routes and the place function of the settlement.

**2.7.9** Providing a bypass has long been the favoured means of reconciling this conflict, but such schemes are costly and take many years to deliver. Where this is not possible, the reduction in traffic speed through the sensitive redesign of the principal streets offers an alternative, as illustrated in the Clifton example below.

## Key Issues

**2.7.10** There are often concerns over the urbanising effect and visual intrusion of unsympathetic highway features such as traffic signs, road markings, street furniture and excessive carriageway width. These can be in conflict with local place functions. The opportunity for designers to employ 'natural' features should be considered, for example grass or grassy banks, appropriate trees and shrubs and also seating.

**2.7.11** In the past highway authorities may have chosen to apply national road standards through rural villages on the basis that the streets are on a classified route. Unless the streets are part of the trunk road network, there is no requirement to apply DMRB standards, and a more place-sensitive approach should be used.

**2.7.12** As with larger settlements, experience shows that a more sensitive approach can bring significant benefits.

### Clifton Village Traffic Calming

The main street through Clifton village, Cumbria, is the A6, a former trunk road. Heavy traffic now uses the nearby M6. This left a wide road, with many signs and lines, carrying relatively light local traffic, although it is still used by some heavy vehicles.

Instead of a conventional traffic calming scheme with yet more signs and lines, a scheme was designed to introduce measures that protected and enhanced the appearance of the village, as well as reducing speed. The design concept was to show to drivers that they are not just driving down a road, but through a village where people live.

At regular intervals the footway was widened and the road narrowed to 6 metres, wide enough for two heavy vehicles to pass. These narrowings are spaced within sight of each other, to continually reinforce to drivers the message that they need to keep their speed down. Each of the locations where the footway was built out relates to an important building in the village, such as the school, the church and the pub. These are emphasised by specially designed plaques on planters. Centreline markings have been removed throughout the length of the village.

Following implementation of the scheme the all-vehicle traffic speed has reduced to 27mph (average) and 34mph (85th percentile).



George and Dragon Pub before; and after, showing carriageway narrowing and planters



## 2.8\_ Context - Rural Areas

### Common Street Type: Rural Roads and Lanes

**2.8.1** Rural roads are an integral part of the landscape, often reflecting and preserving historic landscape features such as ancient routes or field boundaries and set within outstanding countryside. Elements such as hedges, verges, banks and fingerposts may contribute strongly to local character and historic significance.

### Typical Characteristics

**2.8.2** There is a considerable variation in the highway network running through rural areas from motorways to Green Lanes. The majority of other rural roads follow old pathways and boundaries and do not conform to present guidance on highway standards. Indeed to attempt to do so could be to the detriment of local character and lead to intrusion into some of our most outstanding landscapes.

In April 2008, Dorset County Council formally adopted a rural roads protocol setting out their new approach on how to manage the roads in Dorset's countryside. The protocol's main principle is to use the local setting and distinctiveness of the rural environment to guide their management decisions. All future work on rural roads and streets will:

- Balance the safety and access needs of users with care for the environment and the quality of our landscape and settlements
- Use local materials and design schemes to be sympathetic to the character of our rural settlements
- Consider the landscape adjacent to the road and address ecological and historical needs and interests
- Address sustainability and consider the potential impacts of climate change, ensuring that our management of rural roads and streets does not create or contribute to foreseeable environmental problems in the future
- Keep signs, lines and street furniture to the minimum needed for safety and remove intrusive roadside clutter
- Where signs and markings are needed, we will adapt standard designs wherever possible to make them the best possible fit with local surroundings
- Encourage and test innovative approaches and make full use of the flexibility in national regulations, standards and codes of practice

**2.8.3** A number of local authorities have developed policies sensitive to local context. Dorset County Council's<sup>18</sup> approach to the design and management of rural highways is given in the Example below.

### Movement and Place Function

**2.8.4** Outside villages most rural roads connect small settlements and farms to local centres and the wider highway network. Their predominant function is movement, although there is often a leisure aspect to this; walking, cycling and equestrian. Some routes also attract car drivers on leisure routes such as in the National Parks.

**2.8.5** Whilst these routes are largely subject to the national speed limit, their curvilinear nature can encourage speeds well below 60mph, the clear exception being the busier and more direct 'A' roads. However most of these routes are single carriageways where the speed of HGVs is limited to 40mph, and as a result they often act as a constraint on car speed.

**2.8.6** On the more lightly trafficked rural lanes Devon County Council<sup>19</sup> offers the good practice advice in the Example overleaf.

There is a large network of minor roads in Devon. Most junctions are T-junctions or crossroads and on occasions, a road has a split junction, leaving a small grass area between the carriageways. Junction improvements are sometimes necessary on safety grounds or as a result of development in an area. Whilst legislation sometimes requires specific standards to be met, some regulations do allow flexibility. The design of any new scheme should use the existing topography, vegetation, buildings and other structures, so that they appear an integral part of the landscape and historic road pattern. Solutions should reinforce local identity by careful choice of detailing, materials and street furniture.

Roundabouts are normally associated with urban areas or major roads, where the volume of traffic means they are considered to be essential. Regulation requires lighting, mandatory signs and lines to a satisfactory standard at roundabouts and this can be inappropriate in rural areas. In view of this, other junction treatments are preferable.

Junction improvements will only be considered where there is a proven safety need and the introduction of a roundabout should only be considered as a last resort.

Wherever possible, the area of carriageway should be reduced and the road realigned rather than use large areas of hatching.

There should be a presumption of retaining trees, hedges and verges including any central grass areas.

If a traditional Devon hedge needs to be removed for the realignment of a road, the practicality of translocation/moving the hedgebank should be considered in the first instance. Where this is not feasible, the next option should be to carefully dismantle and reconstruct the hedge. Archaeological recording and supervision may be required.

Lighting will not be installed on roads outside settlement boundaries unless there is a proven and overriding safety reason which cannot be addressed by other means. Where considered necessary, the highway authority will consult with landscape managers during the design stage. The preferred option is to install high-reflective non-illuminated signs.

Signing will be kept to a minimum and will be located with a view to minimising the impact on the landscape and the rural character of the area, as well as with a view to safety and utility.

Detailing and choice of materials will respect the local environment and standard solutions or components will not always be appropriate. Kerbing of central grass areas should be avoided. Chevron blocks around the edge of the roundabout are not appropriate and should not be used.

## 2.9\_ Context: Urban and Rural Settlements

### Street Types: Shared Space



New Road, Brighton

### Typical Characteristics

**2.9.1** Shared Space is predominantly an approach to highway design and is introduced for a range of purposes including:

- improving the built environment;
- giving people freedom of movement rather than instruction and control;
- improving the ambience of places;
- enhancing social capital;
- enhancing the economic vitality of places; and
- safety.

**2.9.2** Many local authorities' objectives can be addressed through pedestrianisation. However, for practical purposes and in some settings, Shared Space may be more desirable for a number of reasons.

**2.9.3** A characteristic of many Shared Space schemes is the minimal use of traffic signs, road markings and other traffic management features. With less or no traffic management, or clear indication of priority, motorists are encouraged to recognise the space as being different from a typical road and to react by driving more slowly and responding directly to the behaviour of other users (including other motorists) rather than predominantly to the traffic management features. This approach takes place against a backdrop of concern at the proliferation of features such as pedestrian guardrailing, traffic signs and highway regulation which, it is argued, reduce users' understanding of the complexity of the street environment and their personal responsibility for safe and appropriate behaviour.



**2.9.4** Some Shared Space schemes also feature a level surface. In these cases, kerbs are omitted and there is no level difference between pedestrians and vehicular traffic. The aim of reducing the definition of areas for pedestrians and vehicles is to indicate that the street is meant to be shared equally by all users of the highway. Indication of implied priority for motor vehicles is removed, as is a physical and psychological barrier to pedestrians which might discourage their using the full width of the highway. Ideally, people should be able to not only cross the street wherever they want to, but occupy the full width of the street too.

## Movement and Place Functions

**2.9.5** Shared Space can maintain access for public transport, cyclists, disabled people reliant on cars, passing trade, and delivery vehicles that might otherwise be excluded. It can also reduce the network impacts of entirely closing a link to traffic. Shared Space also addresses a particular problem which can affect some pedestrianisation schemes, where the absence of vehicular traffic can lead to them becoming lifeless places at night. This can give rise to personal security issues.

**2.9.6** Several terms are currently in use aimed at describing Shared Space. At the time of publication the following definitions are used:

- **Shared Space:** a street or place accessible to both pedestrians and vehicles that is designed to enable pedestrians to move more freely by reducing traffic management features that tend to encourage users of vehicles to assume priority.
- **Level surface:** a particular type of Shared Space where the street surface is not physically segregated by kerbs into areas for particular uses. Not all parts of a level surface are necessarily shared as other features, such as street furniture, may physically prevent vehicles from occupying certain parts of the space (see next).
- **Comfort space:** space(s) within the scheme designed to discourage or prevent vehicular access so that pedestrians can choose whether to mix with vehicles or not.

**2.9.7** In historically sensitive environments, creating a level surface may result in the loss of significant features such as historic kerb lines, and creating surfaces with contrasting tones may be visually intrusive. English Heritage's 'Streets for All: Practical Case Study 6: Tactile Paving'<sup>20</sup> illustrates how natural materials can be used to achieve contrast in sensitive areas.

## Key Issues

**2.9.8** A number of emerging design issues have been identified in the ongoing DfT research project on Shared Space<sup>2</sup>. These are summarised below:

- there is a need to take a comprehensive approach to the design of Shared Space schemes, with clear objectives as to what the scheme is meant to achieve;
- establishing a multidisciplinary team at an early stage in scheme development is important;
- there is a need for close and continued engagement with interested parties, including groups representing vulnerable users;
- achieving vehicle speeds of under 20mph is likely to be important to achieving the full potential benefit of schemes;
- it may be necessary to consider traffic network design to manage the flow of vehicles such that pedestrians are willing to use the space as intended;
- schemes need to be designed in three dimensions, as vertical features and cross sections can influence driver speed;
- Shared Space schemes seem likely to be most effective when they provide a comprehensive redesign of the space - just adding or removing specific design features without regard to context or integration of other design elements is unlikely to be satisfactory;
- transition zones or gateway treatments can be useful for indicating to motorists that they are entering a place where they need to drive at low speed and with caution, and for encouraging them to adjust their behaviour prior to encountering significant numbers of pedestrians;
- tactile features for blind or partially sighted people are required to enable them to navigate the space;
- control of parking needs to be considered in level surface schemes;
- with level surfaces designing for drainage needs particular care because of the lack of conventional carriageway cross falls and kerbs; and
- providing surfaces in contrasting tones can assist partially-sighted pedestrians in orientating themselves within a street. However colour fading, dirt, wet weather, low light etc. may affect the level of contrast.

**2.9.9** These considerations will be reflected in the final design guidance which will result from the ongoing research, expected to be published by DfT in 2011.

## 3\_ Highway Design, Risk and Liability

### 3.1\_ The Need For Additional Clarification

**3.1.1** MfS1 sought to assuage fears of some highway authorities, when considering more innovative designs at variance with established practice, concerning liability in the event of damage or injury. Whilst this was accepted by some it is clear that there is a need for more guidance on risk and liability.

**3.1.2** Since the publication of MfS1, the UK Roads Board has published a second edition of Highway Risk and Liability Claims (HRLC)<sup>21</sup>. All those with an interest in highway design are strongly recommended to read this comprehensive document.

**3.1.3** The document is quoted below more extensively than was its predecessor in MfS1 to raise awareness of the issues and demonstrate how few cases arise due to alleged defects in design and to give greater confidence to designers to respect local context and move away from a standardised, rigid approach.

**3.1.4** The HRLC document sets out the legal uses and obligations of users of the highway.

#### Uses of the Highway

**3.1.5** When discussing the rights to use a highway, reference should be made to the following:

*“the public highway is a public place which the public may enjoy for any reasonable purpose, provided the activity in question does not amount to a public or private nuisance and does not obstruct the highway by unreasonably impeding the primary right of the public to pass and repass”* Lord Chancellor, DPP v Jones 1999

**3.1.6** This shows that the public highway is not merely a piece of infrastructure for moving from place to place. It is a place in its own right that can be used for any purpose that does not cause nuisance or obstruction.

**3.1.7** The Highway Code<sup>22</sup> provides a guide to the use of the highway and confirms that users must behave reasonably, taking into account other people and local conditions.

**3.1.8** Key guidance from the Highway Code states that people must not drive dangerously, without due care and attention or without reasonable considerations for other road users. It goes on to say:

*‘Adapt your driving to the appropriate type and condition of road you are on. In particular*

- *do not treat speed limits as a target. It is often not appropriate or safe to drive at the maximum speed limit*
- *take the road and traffic conditions into account. Be prepared for unexpected or difficult situations, for example, the road being blocked beyond a blind bend. Be prepared to adjust your speed as a precaution*
- *where there are junctions, be prepared for road users emerging*
- *in side roads and country lanes look out for unmarked junctions where nobody has priority*
- *be prepared to stop at traffic control systems, road works, pedestrian crossings or traffic lights as necessary*
- *try to anticipate what pedestrians and cyclists might do. If pedestrians, particularly children, are looking the other way, they may step out into the road without seeing you’* (Highway Code Rule 146)

**3.1.9** It is clear that the Highway Code requires drivers to have regard for other road users particularly children, which is confirmed in the case of Russell v Smith:

*“The Highway Code requires motorists to take particular care in looking out for children in built up areas and to travel at an appropriate speed. In the case of Russell v. Smith and Another 2003 EWHC, a motorist, Miss Smith collided with a young cyclist who had emerged into her path from a side road. Failure to observe a provision of the Highway Code is something which a court can take into account when assessing liability, and does not involve fault on the part of the driver. The court judged that Miss Smith had failed to observe the provisions of the Highway Code that requires drivers to have regard to the safety of children in a residential area, and was held partly liable.”*

**3.1.10** There has been a long standing principle, as restated in the Gorrings v Calderdale ruling, that drivers are responsible for their own safety.

*“The overriding imperative is that those who drive on the public highways do so in a manner and at a speed which is safe having regard to such matters as the nature of the road, the weather conditions and the traffic conditions. Drivers are first and foremost themselves responsible for their own safety”.*

*"Many more accidents occur on the wider, and should be, safer roads than upon the so-called dangerous ones. I have in some cases, widened turns to render them safer, but more accidents have ensued owing to motorists taking the turns much faster."*

H T Chapman, County Surveyor of Kent, September 1932

In 1954 in the paper 'Road Design in relation to Traffic Movement and Road Safety Proceedings of the Institution of Municipal Engineers', the author R J Smeed reported on research that had found a relationship between increased carriageway width and increases in the average speed of traffic, and conversely reductions in radius of curvature of highways and reductions in speed of traffic.

## Risk Compensation

**3.1.11** Risk compensation, whereby a driver is assumed to adjust behaviour in response to perceived changes in risk is reflected in MfS1 but there is evidence of this dating back to the 1930s: (See Example above).

**3.1.12** The evidence based approach set out in MfS1 used the research findings of 'The Manual for Streets: Evidence and Research', TRL661<sup>23</sup>, in concluding that a number of environmental factors influence driver behaviour to bring about this compensation. (See **Chapter 8**.)

## Design, Defects and Liability

**3.1.13** Streetscape and highway design have been devolved to local authorities. However, some highway authorities do not take advantage of this and can shy away from developing local guidance for fear of litigation. However, HRLC refers to a survey it conducted to assess the scale of cases relating to defects in design.

*"There have been very few cases relating to alleged defects in design. A request went out to members of the CSS [now ADEPT] in 2008 for cases that had gone against the authority on the basis of design. There was no significant history. There was a small number of live cases that were tending to focus on trip hazards resulting from design. There is of course nothing stopping an individual making a claim for a design defect, however the instances seem rare and the chances of success remote."*

## 3.2\_ Design Guidance and Professional Judgement

**3.2.1** For some time there have been concerns expressed over designers slavishly adhering to guidance regardless of local context. Local Transport Note 1/08 specifically advises:

*"Regulations and technical standards have a key role in the delivery of good design, but, if used as a starting point, they may serve to compromise the achievement of wider objectives. A standards-based template view of road junction design, for example, is inappropriate". LTN 1/08 3.2.1<sup>24</sup>*

**3.2.2** In reality, highway and planning authorities may exercise considerable discretion in developing and applying their own local policies and standards.

*"Designers are expected to use their professional judgement when designing schemes, and should not be over-reliant on guidance". LTN 1/08 3.2.3<sup>24</sup>*

*"Available guidance is just that, guidance, and cannot be expected to cover the precise conditions and circumstances applying at the site under examination." LTN 1/08 3.2.2<sup>24</sup>*

**3.2.3** On this issue HRLC states:

*"The authors of guidance, how ever accomplished, will not be cognizant of the site and situation in question. It would be neither reasonable nor rational to presume that anyone could produce an optimal design in abstract. The informed judgement of trained professionals on-site, should logically take precedence over guidance."*

## 4\_ Design and Implementation Process

### 4.1\_ Introduction

**4.1.1** A generic design and implementation process was set out in MfS1 which leads from local policies through design, auditing, approval to implementation and monitoring. This process can be applied to all types of projects from new development to changes to existing streets.

**4.1.2** The detailed process given in MfS1 was primarily for new development. For existing streets the following example of a design process can be applied and is taken from Local Transport Note 1/08<sup>24</sup>.

**4.1.3** This process emphasises the need for a clear vision, a multidisciplinary team and the monitoring of the performance of the completed project.

### 4.2\_ Community Involvement

**4.2.1** On many schemes there will be a need for thorough public consultation and involvement. The Mixed Priority Route projects (see LTN 3/08<sup>1</sup>) all spent considerable time and effort to consult widely which resulted in much improved and well-received schemes.

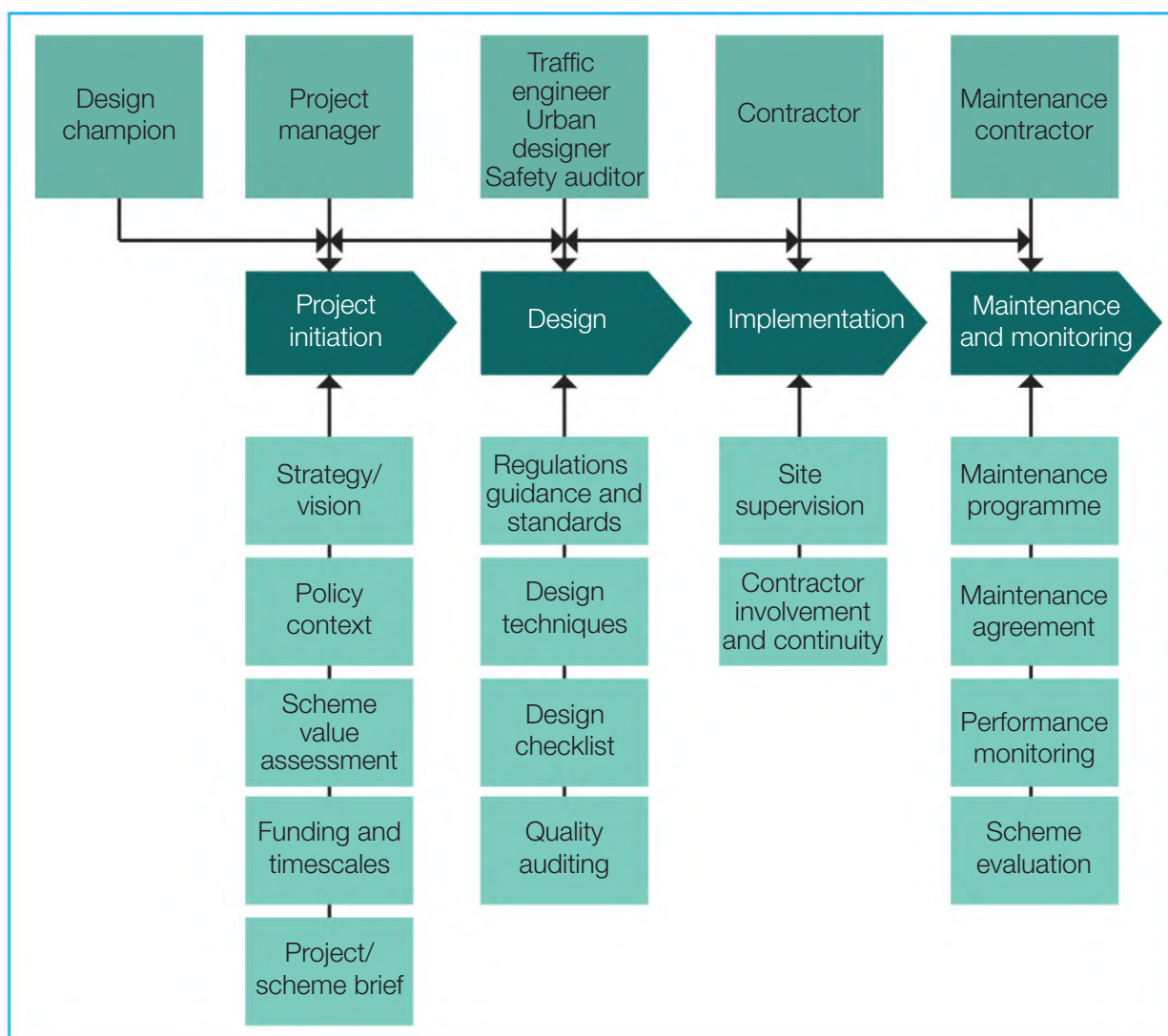

Figure 4.1: The Design Process - Flows, Inputs and Links, from LTN 1/08

**4.2.2** These principles can also be applied on small low-budget schemes, for example the Sustrans DIY Streets project which is yielding significant benefits to local people, see Example below.

guidance on how to provide better streets and a series of staged actions to deliver them. MfS and the Better Streets strategy share a consistent philosophy.

#### DIY Streets – Active Collaboration.

This Sustrans project involves local people in designing modest but effective improvements to the streets where they live, using the principles of the first ‘woonerf’ schemes in the Netherlands (and which formed the basis of UK Home Zones).

A total of 12 projects have been implemented, all of which have been founded on extensive collaboration with residents. Sustrans has developed a toolkit of low cost interventions to help groups develop future similar schemes. See <http://www.sustrans.org.uk/what-we-do/liveable-neighbourhoods/diy-streets> for more information



Designing with residents, on street



Mina Road, Bristol – Before



Mina Road, Bristol – After

### 4.3\_ Stages of Improvement

**4.3.1** Significant improvements to existing streets can be delivered with relatively little effort by applying the principles of MfS during ongoing maintenance. A similar approach has been developed by the Urban Design Team within Transport for London Group Planning on behalf of the Mayor of London in his 'Better Streets strategy'<sup>125</sup> published in November 2009 and the 'Mayors Transport Strategy' published in June 2010. These provide

**4.3.2** The strategy sets out five practical steps to delivering better streets. The steps are progressive, moving from simple measures through to the complete transformation of streets, and more than one can be done at the same time. Steps One to Four can be undertaken in the course of routine maintenance, or small-scale improvements. These can be inexpensive to implement from an engineering point of view and can be carried out quickly.



## 0. Existing Street

Considering a typical street in the UK, the strategy sets out five practical steps to deliver better streets.



## 1. Tidy Up

Get rid of unnecessary road markings and bits of kit that are easy to lift and remove. Remove things such as unwanted or broken seats where removal is simple and will not damage the footway or repair them where appropriate.

## 2. Declutter



More thoroughly, justify each piece of equipment and obstruction with a presumption that it should be removed unless there is a clear case for retention, for example its contribution to the historic character of the area. Look particularly carefully at the need for signs, posts, guardrails, bollards and road markings.

## 3. Relocate/merge functions



Make the remaining street features and equipment work together, maybe putting multiple signs on poles, private boundary walls, railings or buildings when possible or installing a furniture zone in preference to scattering objects across the pavement width.

## 4. Re-think traffic management options



Consider how pedestrians, cars and cyclists use the area and rebalance priorities. This might mean, for example, eliminating some traffic signals, removing redundant carriageway width and providing more generous pavements, creating indirect driving lines, or reverting to traditional two-way roads where practical.

## 5. Re-create the street



Totally remodel the space creating a very different place. This type of approach is likely to be appropriate in very carefully chosen locations. It should be very well designed, with the aid of extensive consultation, and carefully implemented with consideration to the effects on how the historic environment contributes to the sense of place and to the needs of all users. High quality materials and craftsmanship are essential.

images copyright of Transport for London

## 4.4\_ Developing a Quality Audit Process

**4.4.1** Quality Audit (QA) was first described in general terms in MfS1. QA is a process whereby a series of discrete evaluations are collected and given due consideration within the design process throughout the life of a project.

**4.4.2** Quality Audit is recommended as integral to the design process, from initial conceptual designs when a vision for a scheme is developed and including criteria for success, e.g. not just reducing collisions or congestion but also increasing footfall and use of places. For larger schemes this will require a team approach whereby all those with an interest at some stage in the project, including the general public and disability groups, are brought together to identify and resolve competing objectives. QA is appropriate for both large and small schemes and for changes to existing streets. It could become part of the Design and Access Statement required for submission with a Planning Application.

**4.4.3** A number of local highway authorities and consultants are already involved in QA processes, which include a Road Safety Audit (RSA). More are involved in undertaking road user audits in addition to RSA on some schemes, (see Examples from Kent and Solihull).

**4.4.4** It is recommended that local highway authorities set down a process for implementing and documenting QA, including procedures for resolution if various audits or assessments are in conflict.

**4.4.5** The design process should start with an evaluation of what is already there in the street, and how it operates. Street character assessments, including reviews of existing adjacent streets, can help to inform decisions on appropriate materials for new streets, and it may be possible to draw from local designs in designing street furniture. This is a useful way to assess whether items of street furniture (such as signs, posts or bollards) are redundant and can be removed. This approach will be particularly important in conservation areas, national parks, World Heritage sites and other environmentally sensitive areas. Hampshire County Council has adopted a 'Companion Document to Manual for Streets'<sup>26</sup> which sets out its approach to street characterisation in a wide variety of settings.

**4.4.6** The review might consider the following:

- A record of the geometry of the street, including distances between buildings and widths of pavement.
- A record of the materials that are in use. This may include:
  - Old granite kerbstones, which are very durable and often remain
  - Stone paving slabs
  - Stone setts in the road (which may be covered by a layer of black-top)
  - Granite setts, for example marking the channel or around cellar entrances
- Details of any street furniture that adds to a sense of place including historic street signs and fingerposts, milestones, traditional phone boxes and features such as horse troughs or drinking fountains. Some of these may be heritage assets of local or national significance, as defined in Planning Policy Statement 5 (PPS5): 'Planning for the Historic Environment'<sup>27</sup>. In Wales further advice design is contained in Technical Advice Note 12<sup>28</sup>. Locally specific information is available from the relevant local authority's Historic Environment Record (HER) and from English Heritage regional offices and in Wales from Cadw.

**4.4.7** Further information is available in English Heritage's 'Streets for All'<sup>29</sup> publications.

**4.4.8** A QA could comprise a number of discrete studies including:

- Road Safety Audit (RSA) possibly including a Risk Assessment
- Cycle Audit
- Visual Quality Audit
- Access Audit
- Walking Audit
- Cycle Audit
- Non-Motorised User Audit
- Community Street Audit
- Placecheck

**4.4.9** Other issues that may need to be considered in the QA process include parking, servicing, public transport, impact on utilities, trees and planting, drainage etc.

**4.4.10** The various audit reports should be brought together in order to identify any conflicts that may arise, with a view to seeking a balanced response.

**4.4.11** The following examples show how two authorities, Kent and Solihull, have approached Quality Audits.

### Kent Design Guide

*"The Quality Audit is carried out by the **Development Team**. This team is assembled by the Local Planning Authority and is made up of all relevant professionals. Its purpose is to work with the developer's **Project Team** to achieve a high quality development that is attractive, functional and safe. Within the Development Team there will normally be at least one Development Planning Engineer representing Kent Highway Services. All development proposals which involve the creation of new streets (as part of the public realm) should be subject to a Quality Audit, albeit the team size and detailed approach should reflect the scale of the proposal.*

*Development Planning Engineers are primarily responsible for assessing the public realm for functionality and safety, and for making the highway authority's recommendation to the Local Planning Authority. The recommendation should be discussed with the Development Team before it is formalised. **Road Safety Audits** will normally figure in the assessment, but they will not direct it.*

*Quality Audits bring together the various assessments of public realm. The Development Team, and not individual professionals, decides on the balance to be struck between the outcomes. As such, Road Safety Audits have no superior status. Many Development Planning Engineers have been making value judgements on attractiveness, functionality and safety for years. Increasingly, their role will be one of 'placemakers', hence they will become adept at interpreting Road Safety Audits and understanding the risks to which the findings direct the Project Team's attention. They will also develop the skills necessary to contribute positively and creatively to the placemaking agenda, not restricting themselves to the application of standards.*

*The Local Planning Authority's Case Officer will keep a record of the Quality Audit inputs and decisions. This will be sufficient to deal with enquiries in the very unlikely event of an incident being attributed to the design of the public realm. A copy of the Quality Audit should be kept on the planning file(s) and any subsequent adoption agreement file."<sup>30</sup>*

### Quality Audit Process: St Mildred's Tannery Canterbury, Kent

*St Mildred's Tannery was the last major site in the historic city centre of Canterbury to become available for redevelopment. Since the 1980s, development plan allocations had moved from multi-storey car park, coach park, major hotel and supermarket to mainly residential with a limited amount of commercial floorspace. The latter element was eventually identified as a small retail centre and a small hotel.*

*The site had ground contamination problems, lies in a flood risk area and had, for centuries, been inaccessible to the public. Redevelopment offered the opportunity to open up important riverside and other pedestrian and cycle routes in the area, as well as create a lively new 'quarter' of the city.*

*A Development Brief, prepared by a City Council multidisciplinary team, was subject to wide consultation and member approval. The Brief not only established the principles of development, including listed building retention, scale and massing, permeability and street forms, but it also established the Development Team principle for the assessment of detailed schemes.*

*Two detailed proposals, both of which were worked on by the Development Team in partnership with the developer's Design Team, were rejected by the City Council's Planning Committee. The third scheme was deemed to be in accordance with the Development Brief. Long before the third proposal reached the Committee stage, the Development Team agreed the*

*street layout and then invited highway maintenance experts to comment upon proposals for street materials.*

*Certain materials were rejected because they were considered to be unsuitable, but alternatives appropriate for this important part of the city centre conservation area were suggested and accepted.*

*Parking provision, at well below one space per unit, was agreed as being in line with established and emerging policies and guidance, and the site was considered to pass all relevant tests for travel sustainability and transport impact. No major highway infrastructure improvements were required, but an important addition to the riverside walking and cycling route will be delivered.*

*Over 400 units of residential accommodation are being built, along with the small retail centre and small hotel.*

### Quality Audit Actions

- *Development Team approach established for Development Brief preparation and carried through to consideration of detailed proposals by the Design Team.*
- *Additional expertise called upon at appropriate stages of assessment.*
- *Ongoing involvement of Development Team during construction, including visits by Planning Committee members.*
- *Continuing liaison with Project Manager and Agreement Engineers, until development is completed.*



### Case Study: Quality Audit Process Adopted by Solihull

As part of regeneration in North Solihull a new village centre, North Arran Way is being built with a high street designed around guidance in Manual for Streets.

In conjunction with its development partner, In-Partnership, Solihull MBC has developed a Quality Audit process which has review meetings at four stages of the design process to consider whether the emerging design is meeting the objectives of the street. The review stages are:

- Outline design (pre-planning) – (user and professional audit);
- Detailed design – (professional audit only);
- Completion of construction - (professional audit only); and
- After opening - (user and professional audit).

The objectives for the street identified the need for:

- A high quality public realm that people want to be in, is enjoyable to be in and encourages social interaction;
- The street to be acceptably safe from a highway and community point of view; and
- The street to be functional, so the needs of all users must be considered and catered for as far as possible.

The first stage of the quality audit was carried out at outline design stage before the planning application was submitted. Two review meetings were arranged. The first meeting was with invited representatives from user groups. The user audit was held close to the development site and representatives from the following groups invited: visually impaired, mobility impaired, other disabled users groups, school children, local people including the elderly, pedestrians and cyclists and potential high-street shopkeepers, Solihull cycle campaign, the public transport operator, drivers of delivery vehicles, and the emergency services.

Representatives of the Design Team presented the scheme and answered questions. Council officers from planning, transport and highways also took part. The original intention was that a series of questions would be worked through to identify any issues and conflicts. However, the user groups were so forthcoming that no questions were needed to facilitate discussion. Many safety issues were raised and discussed, in particular the challenges of the proposed shared space for visually impaired users. Many solutions were also offered to the Design Team. Structured notes of the meeting were taken and circulated to the Design Team and the officers from the Council.

The outline stage professional audit review meeting took place a week after the user audit. The Design Team again presented the scheme, this time to council officers who included: highway safety, transport planning, landscape, environmental maintenance, street lighting, cycling and planning.

In addition to the Design Team and council officers, two independent reviewers were invited to act as 'independent challengers'. A Road Safety Auditor who had not been involved in the design was invited and also the 'Design Champion' for North Solihull. Their role was to challenge the design for their areas of interest i.e. highway safety and public realm quality. The Design Team and council officers then agreed a response to each point raised. It had been agreed prior to the meeting that if necessary a risk assessment approach would be used to help resolve any areas of tension, but the need for this did not arise.

The results of the user audit were worked through in addition to comments raised by council officers and issues raised by the 'independent challengers'. The discussion and agreed decisions were minuted and action points for the detailed design agreed.

Further professional audits are planned at the detailed design stage and on the completion of construction. These audits will also include the 'independent challengers' looking particularly at highway safety and public realm quality.

A final user audit will then be carried out when the scheme is completed and opened.

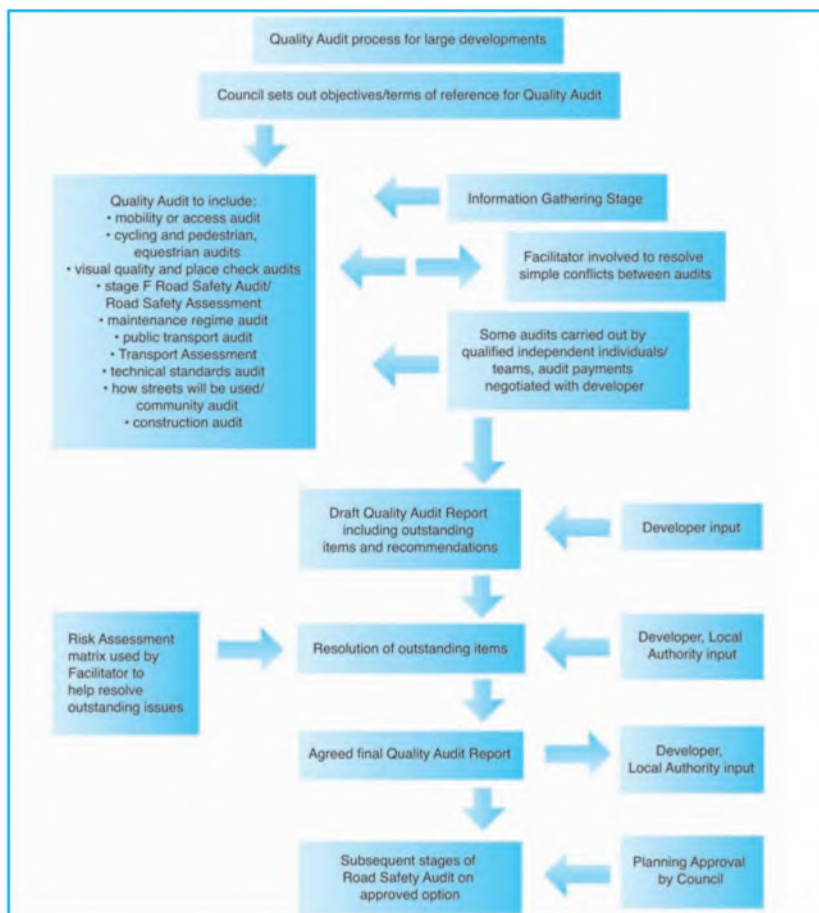

Figure 4.2 - Example Quality Audit Process (Source: Solihull MBC)<sup>31</sup>

## 4.5\_ Road Safety Audit

### Safety Audit and Risk Assessment

**4.5.1** The aim of Road Safety Audit (RSA) is to check that the design has adequately addressed all safety issues in order to minimise the number and severity of situations in which road users are injured whilst using the public highway. This task is undertaken by experienced road safety practitioners who examine new schemes and highway improvements during the design and construction stages (IHT RSA Guidelines, 2008)<sup>32</sup>.

**4.5.2** The RSA process involves the preparation of an audit brief and commissioning of an independent audit team to carry out the audit. The designer responds to the audit recommendations, and the client determines whether to undertake the audit recommendations in the light of the design response. As noted in MfS1, there is no sense in which a scheme 'passes' or 'fails' the RSA process.

**4.5.3** Road safety auditing began around thirty years ago as a means of feeding back cutting edge knowledge on road safety into main stream highway design. Some 25 years later, MfS1 contained qualifications regarding some more recent activity:

*'There can also be a tendency for auditors to encourage designs that achieve safety by segregating vulnerable road users from road traffic. Such designs can perform poorly in terms of streetscape quality, pedestrian amenity and security and, in some circumstances, can actually reduce safety levels.'* MfS 3.7.11

**4.5.4** Such situations may have arisen where an individual auditor had not kept up to date with latest thinking and research on road safety, or where the scheme objectives have not been fully appreciated by the audit team. Safety auditors with an understanding of the latest safety research and knowledge of innovations in road and street design can perform an especially valuable role. Many client organisations now require that safety auditors keep up to date by attending appropriate training courses and seminars.

**4.5.5** Where an RSA is undertaken on highways that fall under the scope of MfS, the audit team should have a sound understanding of the scheme objectives, design principles and research involved. It is important that in the interests of the development of highway engineering that they play the role that was first envisaged, bringing an up-to-date understanding of safety into mainstream highway engineering and public realm practice.

**4.5.6** The RSA procedures set out in DMRB<sup>33</sup> are a formal requirement for trunk roads. Whilst RSA have never been mandatory on local roads, many local authorities have adopted the process. The 2008 IHT (now CIHT) Guidelines<sup>32</sup> advise that local highway authorities should undertake RSA, but set out a more flexible approach than that prescribed for trunk roads.

**4.5.7** In order to mesh with the balanced decision approach of Quality Audits, it is helpful if the RSA contains measured statements where the risk is assessed. The IHT RSA Guidelines contain helpful guidance on Risk Assessment.

**4.5.8** Where appropriate, local highway authorities should consider asking for a Risk Assessment of issues raised in an RSA.

**4.5.9** The recommendations should be reviewed by the designer against the overall scheme objectives. This designer can then prepare a short Design Review Report, which evaluates how each recommendation of the audit balances in relation to other scheme objectives (liveability, sustainability, etc), and states what course of action will be taken for the overall benefit of the public.

**4.5.10** The 2008 IHT RSA guidance on Risk Assessment includes an example of the matrix below.

		Frequency of collision			
		More than one per year	One every 1-4 years	One every 5-10 years	Less than one per 10 years
Severity	Fatal	Very high	High	High	Medium
	Serious	High	High	Medium	Medium
	Slight	High	Medium	Medium	Low
	Damage	Medium	Medium	Low	Low

**Table 4.1:** Risk Assessment Matrix from IHT RSA Guidelines

**4.5.11** The road safety auditor should be able to provide some assessment of the risk, and the reasoning why a recommendation is made. This approach gives the designer a clear indication of the importance of particular issues and problems raised and an audit trail.

## 4.6\_ Maintenance Issues

**4.6.1** Maintenance should play a major part of the design process as ongoing maintenance costs can be an important influence on the quality of a public realm scheme. Whole life costs are sometimes only considered at the later stages of the design process, which should not be the case. Early consideration of maintenance issues during the design process will help to ensure a maintainable scheme is being delivered.

**4.6.2** There is a major opportunity to improve streets when authorities carry out routine maintenance. Carrying out minor street improvements at the same time as maintenance can reduce overall costs. The process of using ongoing maintenance for minor improvement is included in the 'tidy up' and 'declutter' steps in the Mayor of London's 'Better Streets Strategy'<sup>25</sup>.

**4.6.3** The London Borough of Hounslow<sup>34</sup> has developed a method to determine minimum asset provision and levels of service and condition on a very diverse highway network using a location's Link and Place functions; see Example overleaf.

### Using Street Function to Determine Maintenance Requirements

The London Borough of Hounslow is putting into place, supported by an award of £267m of PFI credits from the Department for Transport, a project for the upgrade and maintenance of its highway infrastructure assets over a 25 year period, starting in 2013.

The Council, supported by Mouchel and Professor Peter Jones of UCL, has developed an objective and consistent basis for determining minimum asset provision and appropriate levels of service and condition on each part of a very diverse highway network. It has done this by codifying the use made of each part of the network, in terms of its Link and Place functions. The assigned Link and Place status determines the maintenance and serviceability requirements for a section of street, with Link carrying most weight for carriageways and the Place for footways.

The street network in the Borough consists of around 400km of carriageway and 700km of footway; this has been divided into around 2,000 street sections for highway maintenance purposes. Each section has been assigned a Link value and a Place value, on a scale from 1/A (high) to 5/E (low), based on a series

of guidelines. For example, a section with two or three bus routes would have a minimum Link value of 3, and the presence of a primary school would result in that section having a minimum Place value of D.

These values are used to determine:

- The minimum condition at which maintenance is required to maintain required levels of service on a section of carriageway or footway
- The standard to which the carriageway or footway should be maintained, or reconstructed
- Whether a below-standard street section is eligible for a wider boundary-to-boundary treatment scheme (a so-called Whole Street Environment scheme) and
- The level of financial deduction – and by implication the degree of incentive – that is applied when the PFI contractor fails to meet contractual requirements on a particular length of street

The Council has developed a new Streetscene Design Guide\*, which sets out these and other principles that should be used by all bodies involved in the planning, design, construction and maintenance of Hounslow's roads and streets.

\* Hounslow Street Design Guide, Streetcare Services, London Borough of Hounslow, Currently in draft

**4.6.4** During the design process the maintenance issues related to the following street elements and issues need to be considered:

- Street Furniture including signs and lighting;
- Footways;
- Vehicle overrun areas;
- On-street loading and parking bays;
- Carriageways;
- Street Cleansing - Chewing Gum / Staining;
- Vandalism;
- Security;
- Stock Pile/Storage of materials; and
- Finishings.



Bespoke street furniture



The photographs above show examples of how a scheme has failed as a result of poor design and construction. In the left hand case the restraining edge to the natural stone sets has failed under vehicle loading thus resulting in failure to the paved area. The right hand case is a further example of failure due to loading.

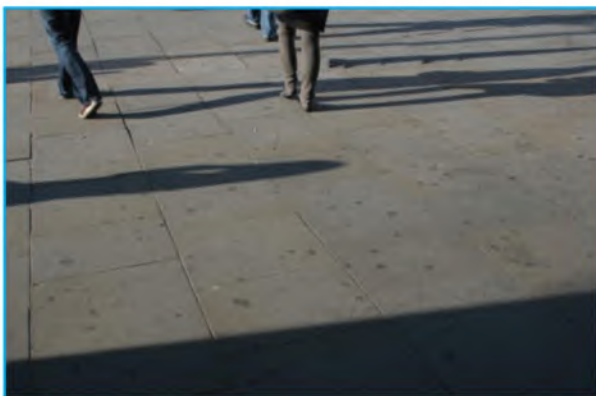

Damage to concrete pavements due to scraping off chewing gum and visual impact of chewing gum on footways

# Section B

## Detailed Design Issues

Section B of MfS2 provides guidance on geometric and other parameters for new and improved highways. Although numerical values are given in this section, designers are encouraged to take a flexible approach to its interpretation and application, thinking through for themselves the likely outcome of any course of action based on experience and local circumstances.

This section is divided into chapters by area of the highway (carriageway, footway etc) and by design elements (junctions, street furniture etc).

However, in preparing schemes, designers should consider the layout in totality, including the relationship of the highway to its surroundings, both in urban and rural areas.

The highway should not be seen in isolation or simply as a piece of infrastructure. The best highway designs respect their surroundings - the buildings, open space and pedestrian/cycle routes that pass through an area.

## 5\_ Pedestrian Needs and Footways

### 5.1\_ Pedestrian Needs

**5.1.1** Advice on meeting pedestrians' needs, including the geometric design of footpaths and footways is given in Chapter 6 of MfS1, and that advice applies to all highways that fall within the scope of this document. Further guidance on planning and designing for pedestrians is given in the DfT's 'Inclusive Mobility'<sup>35</sup> and the IHT document 'Guidelines for Providing for Journeys on Foot'<sup>36</sup>, further guidance in Wales is contained in Technical Advice Note 18 Transport<sup>37</sup>.

**5.1.2** Encouraging walking has many benefits, including reductions in vehicle emissions and traffic collisions, and improvements in personal health.

**5.1.3** In summary, MfS1 advises that

- The propensity to walk is influenced not only by distance, but also by the quality of the walking experience.
- Good sightlines and visibility towards destinations and intermediate points are important for way-finding and personal security.
- Pedestrian routes need to be direct and match desire lines as closely as possible, including across junctions, unless site-specific reasons preclude it.
- Pedestrian networks need to be connected. Where routes are separated by heavily-trafficked routes, appropriate surface-level crossings should be provided where practicable.
- Pedestrians should generally be accommodated on multifunctional streets rather than on routes segregated from motor traffic. In situations where it is appropriate to provide traffic-free routes they should be short, well-overlooked and relatively wide.
- Obstructions on the footway should be minimised. Street furniture on footways can be a hazard for vulnerable people.
- There is no maximum width for footways; widths should take account of pedestrian volumes and composition.

**5.1.4** These principles are important throughout urban areas, and are not confined to lightly-trafficked situations. Indeed, meeting pedestrians' needs where traffic volumes are higher is vital if this most sustainable mode of transport is to be encouraged.

**5.1.5** This chapter provides key advice on the provision and design of footways; **Chapter 9** deals with crossings and pedestrians' needs at junctions, and **Chapter 12** covers street furniture, including guardrail.

### 5.2\_ Footway Provision

**5.2.1** There are many examples of routes in urban areas that were built without footways where pedestrians still do walk, despite the lack of any formal provision. Many of these routes were built as modern ring roads/relief roads

of the type discussed in **Chapter 2**, which do not perform well in place terms. Moreover, drivers tend to react to the absence of pedestrians by travelling faster, to the detriment of road safety.



Modern urban highways without footways

**5.2.2** Where pedestrians are likely to be present in significant numbers footways should normally be provided along both sides of highways, particularly in urban areas. However, streets without conventional footways may be appropriate where traffic speeds are low and the area operates on 'shared space' principles such as in town or village centres (see **Chapter 2**).

**5.2.3** In town centres and other places where there are high numbers of pedestrians, footways should be of sufficient width to cater for peak demand without causing crowding and the risk that people will be pushed into the carriageway. In some cases, this will mean that space needs to be taken from the carriageway in order to create a better balanced street. It may be possible to achieve this without causing a significant reduction in vehicular capacity by reducing the width of traffic lanes, as set out in **Chapter 8**. It may also be possible to remove lanes without affecting capacity or safety e.g. lightly-used turning lanes.

**5.2.4** Additional footway capacity can also be gained by removing and/or rationalising street furniture, including guardrail - see **Chapter 12**.



**5.2.5** Evidence from the Newland Avenue Mixed Priority Routes (MPR) project (see Example) indicates that providing more generous and better quality facilities for pedestrians can lead to large increases in walking.

The gradient of pedestrian routes should ideally be no more than 5%, although topography or other circumstances may make this difficult to achieve. However, as a general rule, 8% should generally be considered as a maximum, which is the limit for most wheelchair users, as advised in Inclusive Mobility<sup>35</sup>.

The Newland Avenue MPR Project created much more space for pedestrians by narrowing the carriageway to between 6 and 6.5m and removing guardrail. See LTN 3/08<sup>1</sup> for further information.

At a pinch point under a narrow railway bridge, the footway was widened from 1.1m to 1.6m, and the flow of pedestrians increased by around 1,700 per day, an increase of 59%.



Footways widened significantly by narrowing carriageway



A marginal widening of footway led to a large increase in pedestrian flow.

## 6\_ Cycle Facilities

### 6.1\_ Introduction

**6.1.1** Advice on meeting cyclists' needs is given in Chapter 6 of MfS1, and that advice applies to all highways that fall within the scope of this document.

**6.1.2** As with walking, encouraging cycling has many benefits, including reductions in vehicle emissions and traffic collisions, and improvements in personal health.

**6.1.3** In summary, MfS1 advises that

- Cyclists should be accommodated on the carriageway.
- Cyclists prefer direct, barrier-free routes that avoid the need for cyclists to dismount. Routes that take cyclists away from their desire lines and require them to concede priority to side-road traffic are less likely to be used.
- Off-carriageway cycle tracks that bring cyclists into conflict with side road traffic can be more hazardous than routes that stay on the main carriageway.
- Cyclists are sensitive to traffic conditions; high speeds or high volumes of traffic tend to discourage cycling. If traffic conditions are inappropriate for on-street cycling, they should be addressed to make on-street cycling satisfactory.
- Junctions should be designed to accommodate cyclists' needs. Over-generous corner radii that lead to high traffic speed should be avoided.

**6.1.4** This chapter provides key advice on the provision and design of cycle facilities; **Chapter 9** deals with crossings and cyclists' needs at junctions.

### 6.2\_ Cycle Lanes, Cycle Tracks and Markings

**6.2.1** Detailed guidance on the design of specific facilities for cyclists is given in Local Transport Note 2/08<sup>38</sup>, 'Cycle Infrastructure Design' and its advice should be taken into account when highway schemes are being developed.

**6.2.2** Generally the preferred design approach - to enable and encourage increased levels of cycling - is to create conditions on the carriageway so that cyclists are content to use it, particularly in urban areas. This may require reductions in the volume and/or speed of traffic and the reallocation of space away from traffic. Reductions in vehicular lane widths may make it possible to achieve this without causing a significant reduction in vehicular capacity, as set out in **Chapter 8**. However the choice of lane width should carefully consider the ability of motor vehicles to pass cyclists, if necessary. Narrow traffic lanes will help to reduce traffic speed, which will in turn reduce the need for motor vehicles to pass cyclists.

**6.2.3** Guidance on when to provide cycle lanes and cycle tracks is given in Table 1.3 of LTN 2/08<sup>38</sup>, depending on the volume, composition and speed of traffic. A high percentage of larger vehicles, including buses, will increase the desirability of cycle lanes (or alternatively combined bus/cycle lanes).

**6.2.4** Well-designed cycle lanes can benefit cyclists, but poorly designed lanes can make conditions worse for them. All cycle lanes should be of sufficient width as there is evidence that vehicles are driven closer to cyclists when there is a cycle lane<sup>39</sup>. Cycle lanes are more beneficial in the uphill direction as the speed differential between cyclists and vehicles tends to be larger, while cyclists may wander a little as their speed is reduced. A single uphill cycle lane of the recommended width is far preferable to sub-standard cycle lanes in both directions.



Generous cycle lanes, Scunthorpe. Note absence of central white line

**6.2.5** Cycle lanes should be 2 metres wide on busy roads, or where traffic is travelling in excess of 40mph. A minimum width of 1.5m may be generally acceptable on roads with a 30mph limit. Cycle lanes less than 1.2m width are only recommended at lead-in lanes to advanced stop lines where there is insufficient width for wider lanes. Cyclists will also benefit from bus lanes, when provided. Where cycle lanes pass parking and loading bays sufficient margin should be provided to allow for doors being opened.

**6.2.6** In some cases, providing the recommended width of cycle lanes will mean that space needs to be taken from the carriageway. It may be possible to achieve this without causing a significant reduction in vehicular capacity by reducing the width of traffic lanes, as set out in **Chapter 8**. In Cambridge, a scheme is being installed on a busy radial route that reduces the number of traffic lanes to provide wide cycle lanes (See Example overleaf).

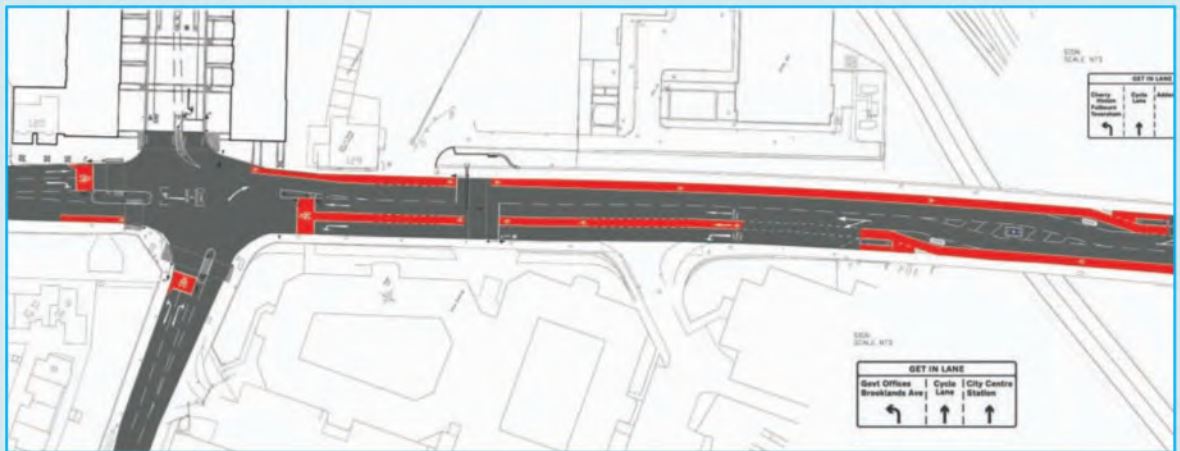

Hills Road Bridge is one of the busiest routes in Cambridge. Formerly a four lane dual carriageway, it caters for over 4,000 cyclists everyday, which often results in conflict for both cyclists and drivers. New 2.1m wide cycle lanes are being installed on Hills Road Bridge, which will allow cyclists to proceed straight ahead safely with motor traffic as the lane moves to the right at the top of the bridge. Cyclists turning left will be provided with a by-pass lane.

**6.2.7** Many authorities have chosen to use blue, red, green or another coloured surfacing for cycle lanes, and this can make them more conspicuous, which is useful at critical locations such as where a cycle lane crosses a junction. However, coloured surfaces can be visually intrusive, particularly if used excessively, and may not always be justified.

**6.2.8** Hybrid lanes are wide cycle lanes with some form of physical demarcation, such as a cobbled strip, between the cycle lane and the carriageway. They offer a greater feeling of protection which is important to less confident cyclists. They are commonplace in the Netherlands and in other countries but are presently rare in the UK.



Hybrid cycle lane, Netherlands

**6.2.9** Using the cycle symbol (diagram 1057), in conjunction with appropriate upright signs but without marking a cycle lane is a way of making drivers more aware of the likelihood of encountering cyclists and confirming to cyclists that they are on a designated route. Placing the symbol away from the kerb also encourages cyclists to take up a safer position in the carriageway and reduces the likelihood of drivers passing too close and forcing them towards the kerb. However, the cycle symbol and associated signs do have a visual impact and add to street furniture and authorities should therefore use this approach selectively.

**6.2.10** Off-carriageway cycle tracks can have advantages, but will generally need to be shared with pedestrians, who may see them as a reduction in provision. They will therefore be the least desired option, particularly in urban areas. More information on the design of shared use schemes is available in Local Transport Note 2/86 'Shared Use by Cyclists and Pedestrians'<sup>40</sup>. This Local Transport Note is in the process of being updated and a replacement document is expected to be published by DfT in 2011.

**6.2.11** Shared use footway/cycle tracks can be segregated into pedestrian/cycle areas using a raised white line or other measure, but these can be omitted on unsegregated routes, reducing street clutter.

## 6.3\_ Cycle Parking

**6.3.1** Convenient cycle parking should be provided at key destinations - for example in local high streets - to support journeys by bike. This may be on the footway but there should be a clear route for pedestrians. As indicated in **Chapter 8**, cycle parking can also be provided along central reservations.

**6.3.2** Public transport accessibility can also be greatly increased by providing good quality cycle parking at key bus and tram stops and at railway stations. Cyclists travel around three times the speed of pedestrians and so the cycle catchment of a stop is around ten times the pedestrian catchment.



Secure, covered cycle parking - Newland Avenue MPR scheme



## 7\_ Bus Facilities

### 7.1\_ Introduction

**7.1.1** Buses carry more passengers than any other public transport mode, and are mainly routed along the more heavily trafficked highways that are covered by this document. Providing good bus services, particularly in urban areas, is fundamental to achieving more sustainable patterns of movement that reduce people's reliance on the car.

**7.1.2** Advice on designing for public transport users and vehicles is given in Chapter 6 of MfS1, with particular emphasis on bus-based transport, and the key points in the document are as follows:

- Bus routes and stops should form key elements within walkable neighbourhoods. Bus services are most viable when they follow direct and reasonably straight routes, avoiding long one-way loops or long distances without passenger catchments.
- Bus stops should be high-quality places that are safe and comfortable to use and highly accessible by all people, ideally from more than one route. Stops should be provided close to specific passenger destinations (schools, shops etc.).
- Carriageways on bus routes should not generally be less than 6.0m wide, although this could be reduced on short sections with good inter-visibility between opposing flows. **Chapter 8** provides more detailed advice on carriageway widths.
- Buses can help to control the speed of cars at peak times by preventing overtaking.

**7.1.3** This chapter provides key advice on the provision and design of bus facilities.

### 7.2\_ Bus Priority

**7.2.1** Bus priority systems are provided to increase the overall speed, efficiency and reliability of bus services in congested conditions, and can be a highly effective way of improving the attractiveness of buses and increasing their mode share. Guidance on the design of bus priority systems is given in Local Transport Note 1/97, 'Keeping Buses Moving'<sup>41</sup> and in 'Bus Priority: The Way Ahead'<sup>42</sup>, published by DfT in 2005.

**7.2.2** Bus priority is most commonly achieved by providing with-flow bus lanes, and unless signed to the contrary they can be used by cyclists. Where roads are wide enough bus lanes should be 4.25m wide and the minimum preferred width is 4m; this allows buses to overtake cyclists safely and reduces the likelihood of interference from general traffic in the adjacent lane. The minimum recommended width is 3m.

**7.2.3** Bus lanes can also be provided in a contraflow direction on streets that are one-way for general traffic, but their use can have road safety implications.

**7.2.4** Providing bus lanes can increase the overall width of the carriageway, which will reduce the space that can be given over to pedestrians, and make it more difficult for them to cross the street. A careful balance will need to be struck between the requirements of these different user groups, taking account of local context.

**7.2.5** In the case of the Walworth Road MPR scheme (see case study in **Chapter 14**), bus lanes were removed in order to enable wider footways to be created, with bus priority being achieved through bus advance facilities.

**7.2.6** Bus advance areas with pre-signals enable buses to move to the head of vehicle platoons by controlling general traffic with a separate signal, which buses can bypass.



Bus Advance Area, Walworth Road MPR scheme

**7.2.7** Many authorities have chosen to use red or another coloured surfacing for bus lanes and bus advance areas, and 'Keeping Buses Moving' advises that this can improve compliance, but it does add to visual impact and so may not always be justified.

### 7.3\_ Bus Stops

**7.3.1** Guidance on the design of bus stops is given in LTN 1/97<sup>41</sup>, 'Keeping Buses Moving', and more detailed advice is contained in the Transport for London document BP1/06 'Accessible Bus Stop Design Guidance'<sup>43</sup> and in DfT's 'Inclusive Mobility'<sup>35</sup>.

**7.3.2** The bus stop is a vital component of the public transport system. Stops that are fully accessible, which feel safe and secure and provide good quality information on services, are vital if patronage is to be increased. As noted above, providing cycle parking at key stops will greatly increase public transport accessibility.

**7.3.3** Well-designed bus stops should enable buses to stop parallel to the kerb and with a kerb of sufficient height (minimum 125mm, but higher kerbs may be desirable) to allow access ramps to be deployed when required.

**7.3.4** Bus shelters are desirable at stops, and the chosen design must also be able to accommodate the numbers of pedestrians likely to wait for buses and any bus information systems that are provided.

## 7.4\_ Bus Laybys and Boarders

**7.4.1** In the past, on busy routes, it was commonplace to place bus stops in laybys so that general traffic was able to pass a bus at the stop, but laybys can create difficulties for buses seeking to rejoin a traffic queue on the main carriageway and can therefore make services slower and less reliable. They also reduce footway width and make conditions worse for pedestrians. Bus laybys should therefore only be used where a stationary bus would otherwise create a significant safety problem.

**7.4.2** Conversely, bus boarders are used to enable buses to stop within a traffic stream and move off without difficulty. They are built out from the existing kerb line where there are parked cars or other obstructions that would prevent the bus from stopping parallel to the kerb, so that people, particularly those with impaired mobility, can get on and off the bus without difficulty. A full width boarder projects a vehicle width into the carriageway - 2m typically, and 2.6m where large vehicles are parked nearby.



Reduced width bus boarder



Full width bus boarder

**7.4.3** Half-width or narrower bus boarders can also be useful, however, where there is insufficient remaining carriageway width for a full-width boarder to be installed or where it is desirable to allow other traffic to overtake a stationary bus.

## 8\_ Carriageways

### 8.1\_ Introduction

**8.1.1** The design of carriageways between junctions in urban and rural areas is often based on TD9/93<sup>44</sup>, 'Highway Link Design', part of DMRB, but that document has been prepared for Trunk Roads and may not always be appropriate in other circumstances. As noted in **Chapter 1** it is recommended that designers bear in mind the key principles of MfS when applying DMRB.

**8.1.2** This chapter provides designers with advice on how carriageway widths, alignments and cross-sectional details can be designed in a way that better respects local context and the needs of users other than motor traffic.

### 8.2\_ Design Speed

**8.2.1** The geometric design of carriageways is generally based on the notion of a design speed, which in the past has tended to be fixed along a route, or a substantial section of a route.

**8.2.2** Design speeds in urban areas (or rural routes subject to a local speed limit) have tended to be based on the advice contained in DMRB TD 9/93<sup>44</sup>, which determines design speed from the existing or proposed local speed limit, but with some allowance for vehicles travelling at higher speeds. In urban areas subject to a 30mph limit, a design speed of 60kph (37mph) has often been used.

**8.2.3** It is now considered inappropriate in areas subject to a limit of 30mph, to adopt a design speed of more than 30 mph unless existing speeds are significantly above this level.

**8.2.4** This is justified by the finding from the research contained in MfS1 that drivers tend to adopt higher speeds in response to more generous highway geometry and that, in recent years, the proportion of vehicles that exceed the speed limit in free flow conditions has been dropping; in 2008 it was below 50%, down from 69% in 1998. Average free flow speeds were 30mph in 30mph limits; and 36mph in 40mph limits<sup>45</sup>.

**8.2.5** In rural areas not subject to a local speed limit, TD9/93 can be taken as a starting point for new routes, which relates design speed to the:

- Alignment Constraint, based on the bendiness of the route (degrees per kilometre) and on single carriageways, the harmonic mean visibility; and the
- Layout Constraint, which measures the degree of constraint imparted by the road cross section, verge width, and frequency of junctions and accesses.

**8.2.6** The finding in MfS1 that the context through which drivers pass does have an effect on their chosen speed is thus explicit in TD9/93<sup>44</sup>, which notes in Para 1.2 that 'Speeds vary accordingly to the impression of constraint that the road alignment and layout impart to the driver'.

**8.2.7** Whilst an appropriate design speed can be determined from the guidance above, designers should also consider the potential for reducing design speed locally, where it is appropriate that traffic should travel more slowly.

**8.2.8** Such situations could include where a major route is passing through the centre of a small town or village, or where there is a site of significant ecological value within the corridor of a highway improvement and where a reduction in design speed would allow a scheme of lower impact to be designed.

**8.2.9** In urban areas, highway space is shared between motor traffic, pedestrians, cyclists and public transport, and keeping speeds low has been demonstrated to have significant safety benefits. MfS1 and DMRB confirm that designing for higher speeds will create an environment where drivers tend to travel faster. Instead, speeds should be designed down to an appropriate level.

**8.2.10** Speed limits of 20mph are now becoming commonplace. Some authorities, such as Portsmouth, have adopted a policy of setting signed-only 20mph limits across most residential areas, which have succeeded in reducing speeds and improving safety.

**8.2.11** Advice on setting local speed limits is provided by DfT and the devolved administrations. In 2009, DfT consulted on a change to Circular 1/2006<sup>46</sup> aimed at encouraging highway authorities, over time, to introduce 20mph zones or limits into:

- streets which are primarily residential in nature; and
- town or city streets where pedestrian and cyclist movements are high, such as around schools, shops, markets, playgrounds and other areas where these are not part of any major through route.

**8.2.12** The Welsh Assembly Government published guidance on the setting of speed limits in 2009<sup>47</sup> which supports the use of 20mph speed limits and zones at appropriate locations, including town centres, residential areas and in the vicinity of schools.



**8.2.13** However, even where a 20mph limit is not appropriate, authorities may still choose to set the design speed for a section of a route to below 30mph. Measures that will help to keep speeds low, particularly in urban areas, are set out in section 7.4.4 of MfS1, and include:

- Physical features
- Changes in priority
- Street dimensions, including width
- Reduced forward visibility
- Psychology and perception - the following features may be effective:
  - Visual narrowing;
  - Close proximity of buildings;
  - Reduced carriageway width;
  - Obstructions in the carriageway
  - Pedestrian refuges and other features associated with activity;
  - On-street parking;
  - Land uses associated with large numbers of people (e.g. shops); and
  - Pedestrian activity.

**8.2.14** Guidance on the design of physical traffic calming measures is given in the IHT publication 'Traffic Calming Techniques' (2005)<sup>48</sup>.

## 8.3\_ Horizontal Alignment

**8.3.1** Parameters for horizontal curves are related to local design speed and radius and are dependent on the limit of sideways force in the bend that can be tolerated by the vehicle without skidding or overturning.

**8.3.2** Desirable minimum horizontal curves set out in TD9/93<sup>44</sup> seek to limit the sideways force to very low levels, commensurate with high speed inter-urban roads, and therefore result in generous curve radii.

**8.3.3** The adoption of gentle minimum curve radii for new highways in urban areas can result in alignments that are inappropriate to the surrounding urban grain, sometimes requiring the acquisition and demolition of existing buildings and creating awkward plots of remaining land. This could be avoided if sharper curves were used. The Sky Blue Way example in **Chapter 2** shows the damage that can result when new highways are designed with generous curvature and widths.

**8.3.4** Tighter radii can be adopted; TD9/93<sup>44</sup> para 3.4 advises that horizontal curves of four steps below desirable minimum radii can be used, "*inter alia*", for design speeds of 60kph and below. The relative sharpness of curves is established by the formula  $v^2/R$ , where  $v$ =design speed (kph) and  $R$ = radius (m).

**8.3.5** Horizontal curves of four steps below desirable minimum (TF9/93<sup>44</sup> para 0.7) have a  $v^2/R$  value of 56, and therefore the minimum horizontal curves corresponding to this criterion are as follows:

Design Speed, kph	Curve Radius, m
	4 steps below TD 9/93 Desirable Min
30	16
40	28
48	41
50	44
60	64

**Table 8.1** - Minimum Recommended Curve Radii

**8.3.6** Superelevation in urban areas should be kept to a minimum, since it is often difficult to achieve due to the frequency of accesses and junctions and other constraints. Excessive superelevation can also adversely affect the relationship between the carriageway and frontage buildings and footways. When it is provided, a maximum superelevation in urban areas of 5% is recommended (TD9/93<sup>44</sup> para 3.2).

**8.3.7** Where it is desirable to provide a horizontal curve below the values recommended in **Table 8.1** above, the preferred solution will often be to reduce the speed of traffic locally, rather than provide steep superelevation, which will tend to encourage higher speeds.

**8.3.8** The presence of a sharp bend will itself lead to lower speeds. Research by TRL<sup>49</sup> showed the following reductions in speed at bends ( $v$  = Approach Speed (kph),  $R$  = Bend radius).

$v^2/R$	Percentage Speed Reduction Due to Bend	
	From 50%ile speed	From 85%ile speed
20	3.5	5
28	5	7
40	7	10
56	10	14
80	14	20

**Table 8.2:** Percentage Speed Reduction at Bends

## 8.4\_ Carriageway Gradients

**8.4.1** A maximum longitudinal carriageway gradient of 6% is desirable (TD9/93<sup>44</sup> para 4.1), although a gradient of 5% is desirable where there are significant numbers of pedestrians walking along the route.

**8.4.2** In hilly areas steeper gradients will frequently be required, but a gradient of 8% should be regarded as a practical maximum unless there are particular local difficulties. This is also the maximum gradient that a manual wheelchair user can negotiate (see guidance on footway gradients in **Chapter 5**).

## 8.5\_ Vertical Curvature

**8.5.1** Minimum length requirements for vertical curves are normally assessed based on two criteria - the comfort of vehicle occupants and the need to maintain forward visibility.

**8.5.2** For design speeds of 50kph and below, where it can be expected that drivers will reduce speed in response to changes of alignment, forward visibility to achieve minimum Stopping Sight Distance (SSD) should be used as the basis of design, but as with forward visibility around horizontal curves, there will be locations where it is appropriate to restrict forward visibility in order to help reduce traffic speeds.

**8.5.3** For design speeds of 50kph and above, designers should follow the guidance contained in TD 9/93<sup>44</sup>.

## 8.6\_ Carriageway and Lane Widths

**8.6.1** UK practice has generally adopted a standard lane width of 3.65m (12 feet) but this should not be taken as a preferred value in all circumstances. This can be an unsatisfactory lane width for cyclists, as there is insufficient room for drivers to pass them comfortably.

**8.6.2** Narrower lanes will be appropriate in many circumstances, particularly in built up areas, resulting in carriageways that are easier for pedestrians to cross and encouraging low traffic speeds without causing a significant loss of traffic capacity. The needs of cyclists will need to be expressly considered however, as discussed below.

**8.6.3** Lane widths should be determined based on the following local consideration:

- the volume and composition of vehicular traffic;
- pedestrian and cyclists' needs;
- the demarcation, if any, between carriageway and footway (e.g. kerb, street furniture or trees and planting);
- whether parking is to take place in the carriageway and, if so, its distribution, arrangement, the turnover of spaces, and the likely level of parking enforcement (if any);
- the design speed;
- the curvature of the street (bends require greater width to accommodate the swept path of larger vehicles); and
- any intention to include one-way streets, or short stretches of single lane working in two-way streets.

**8.6.4** MfS1 Figures 6.18 and 7.1 provide information on the width requirements of different types of vehicle, and these can be taken as a guide to minimum lane widths. These can be applied to links between and at junctions.

**8.6.5** Thus for example, at a traffic signal stop line, where HGVs and buses make up only a small proportion of traffic flow, 2 - 2.5m wide lanes would be sufficient for most vehicles, and would reduce overall carriageway width requirements, making it much easier for pedestrians to cross the carriageway. Lanes wider than 3m are not necessary in most urban areas carrying mixed traffic.

**8.6.6** Carriageway and lane widths do not have to be constant. Varying the width through non-parallel kerb lines or other physical limits can create interest, provide informal parking opportunities at widenings and traffic speed reduction at narrowings. The needs of cyclists at narrowings should be considered in detail.

**8.6.7** The needs of cyclists using the carriageway should be expressly considered when lane widths are being determined. Cyclists should wherever possible be accommodated on carriageway without special provision, based on the recommendations of LTN 2/08, 'Cycle Infrastructure Design'<sup>138</sup>.

**8.6.8** The ideal minimum widths required for vehicles to overtake cyclists in comfort given in LTN 2/08<sup>38</sup> are:

- Car passing at 20mph - 3.8m
- Car passing at 30mph - 4.3m
- Bus/HGV passing at 20mph - 4.6m
- Bus/HGV passing at 30mph - 5.05m

**8.6.9** These are not necessarily lane widths, however. If traffic flows are generally light enough for vehicles to pass cyclists fairly readily by moving at least partly into the opposite lane then the overall carriageway width will be available. Lane widths of 3m or less will make it less likely that drivers will try to squeeze past cyclists without pulling around them.

**8.6.10** Providing a central median that can be overrun is one way of allowing motor vehicles to pass cyclists comfortably without using excessively wide lanes - see Broad Street, Birmingham and Leamington Spa examples overleaf.

**8.6.11** If traffic speeds are higher and motor vehicles are not able to move into the opposite lane to pass cyclists with comfort, then cycle lanes may be justified so that excessive lane widths are not provided, which would otherwise encourage higher speeds. Where there is more than one lane in either direction, some authorities have divided the carriageway into unequal lanes, giving more space on the nearside lane to assist cyclists.

**8.6.12** Lane and carriageway widening requirements for horizontal curves should be assessed using tracking software. The criteria to be adopted should be based on traffic flows and composition. For example, where HGV and/or bus flows are low, it may not be necessary to design carriageways to cater for two large vehicles meeting at a bend, as long as there is sufficient inter-visibility for one driver to stop and wait. The use of overrun areas can be considered - see MfS1 7.11 for further guidance on their use.

## 8.7\_ Refuges, Medians and Central Reservations

**8.7.1** Central medians/reservations and refuges are useful features in urban areas to enable pedestrians and cyclists to cross carriageways in two stages, whether as part of a designated crossing of any type (see **Chapter 9**), on the approach to a junction, or along a highway link. These features can also have a dramatic effect on the character of a highway, and can therefore significantly enhance the sense of place.

**8.7.2** The minimum width of central reservations/medians and refuges should be based on the users anticipated<sup>35</sup>:

- 1.2m - to accommodate pedestrians only, with no street furniture on the median/island
- 1.5m - desirable width to accommodate wheelchair users
- 2.0m - minimum width to accommodate allow wheelchair users to pass one another. This is also the minimum width for cyclists (LTN 2/08 para 10.2.7<sup>38</sup>).



These simple pedestrian refuges were provided on The Parade, Leamington Spa MPR project. Note the absence of keep left bollards, but also the intrusive road markings.

**8.7.3** Narrower medians that can be over-run have also proved useful in some schemes, by giving pedestrians a space to wait in the centre of the carriageway which can also be used by vehicles when they need to pass cyclists or other vehicles. Such medians also allow emergency vehicles to cross over into the opposing lane when necessary.



This informal median on Broad Street, Birmingham has operated successfully for many years

**8.7.4** Formal central reservations, provided on dual carriageway links, can be planted or paved depending on local context and requirements, including the need for pedestrians to cross the carriageway and the local landscape character.



Mature trees in central reservation, Bristol Road, Birmingham. Here the central reservation is of little benefit to pedestrians crossing the route, but the width of the reservation and the mature trees are attractive and make up a vital part of the street's character.

**8.7.5** In urban areas, central reservations should be left unfenced so that pedestrians can cross at any point, unless there is clear safety case for not doing so.



Upper Parliament Street, Nottingham – Unfenced Central Reservation

**8.7.6** If it is of sufficient size, the central reservation can be a place for useful activity. O'Connell Street in Dublin has this form, which is also found at Las Ramblas, Barcelona.

**8.7.7** There are few examples of this type of street in the UK, but The Broadway in Letchworth shares some of the characteristics, although the continuous fencing on both sides has reduced the value of the central space as an accessible and active place.



O'Connell Street, Dublin

**8.7.8** On Kensington High Street, the central reservation has been used for cycle parking. This is a practical use of the space, which also sends a clear signal to drivers that this is a street that cyclists are encouraged to use.



Cycle parking on central reservation, Kensington High Street. Generous spacing between the cycle racks enables pedestrians to cross between the parked cycles.

## 8.8\_ Kerbs

**8.8.1** Historically kerbs were primarily installed to form an edge to the drainage channel and provide a clean walking route in urban areas, but have now come to represent a recognisable divider between the carriageway and the footway. In rural areas they are mainly used to form an edge restraint and drainage feature, but there are many rural roads and streets where there is no kerb and separate footway.

**8.8.2** In urban areas, half-batter kerbs with a standard height of 125mm are often used, but lower kerb heights are easier for pedestrians to negotiate, particularly people with impaired mobility, and can help to reduce vehicle dominance by reducing the degree of segregation.

**8.8.3** Higher kerbs are appropriate at bus stops to allow level access into vehicles - see **Chapter 7** for further guidance on bus stop design.

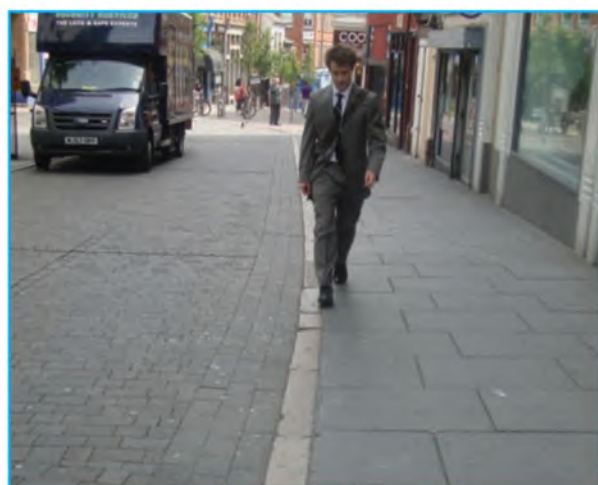

Kerb heights of between 75mm and zero (at informal crossings) were used with streetscape improvements in the centre of Nottingham.

**8.8.4** Low kerb heights may mean that closer gully spacings are required to avoid rainwater run-off from affecting footways during heavy storms.

**8.8.5** Kerbs are often omitted in shared space schemes in order to reduce the separate definition of areas for pedestrians and vehicles and to indicate that the street is meant to be shared equally by all users of the highway. However more subtle delineators such as old granite kerbstones could be used, in a remodelled paving scheme in order to retain historic kerb lines and local character. Further guidance on the use of shared space techniques is given in **Chapter 2**.

**8.8.6** 'Trief' kerbs are designed to deter vehicles from mounting the kerb where high containment is thought to be necessary, but they are more visually intrusive than normal kerbs, are difficult for pedestrians to cross, and have been known to cause small vehicles to overturn. They should therefore not be used without these adverse effects being considered.

# 9\_ Junctions, Crossings and Accesses

## 9.1\_ Introduction

**9.1.1** Junctions are critical places in a number of ways. In traffic terms, they are a potential source of delay and where most collisions tend to occur. They are often seen as a problem in these terms, and highway designers tend to minimise the number of junctions in a network. When junctions are provided or modified, particularly on busier highways, they tend to be designed with the principal aim of accommodating peak hour traffic flows.

**9.1.2** In place terms, conversely, junctions can be seen as an opportunity. By definition they are accessible places from several directions, and so tend to be a good location for buildings that attract significant numbers of people, such as shops and public buildings. Junctions are also the most natural way for people to find their way around an area, whether on foot or in a vehicle, and so are a good place for landmark buildings and other distinctive features, such as public art.

**9.1.3** It is critical therefore to achieve a good balance of place and movement functions at junctions, particularly in urban areas.

**9.1.4** As noted in MfS1 section 7.3, there is considerable flexibility over the form of junctions, which can add to their distinctiveness, so that they function as significant places in their own right.

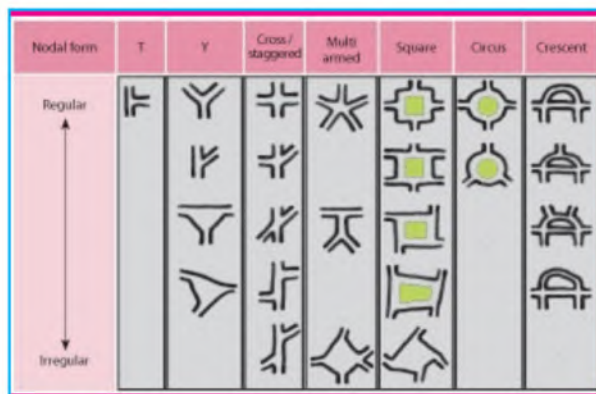

A wide range of junction layouts is possible

**9.1.5** In the past, concerns over capacity and safety have tended to overshadow any concerns about placemaking, and as a result many urban junctions are unattractive and difficult to negotiate, particularly on foot and cycle. Excessive use of guardrailling is a particular problem and further guidance on how to minimise it is given in **Chapter 12**.

**9.1.6** Because junctions are a natural focus for all modes of travel, wherever possible they should include convenient and direct crossing facilities for pedestrians, desirably across all arms.

**9.1.7** Well-designed crossings are of vital importance to the ability of pedestrians and/or cyclists to move around easily and safely.

**9.1.8** Crossings that involve grade separation - subways and bridges - are undesirable and should only be used where essential due to traffic speeds and volumes. Grade separated crossings are much less convenient and therefore less likely to be used, particularly subways which create significant personal security concerns. These types of crossing are much more costly and elevated structures, with their lengthy approach ramps, cause a high degree of visual intrusion.

**9.1.9** Where underpasses and bridges are used, they should be as short, wide and direct as possible to improve users' perception of security and make the routes more legible.

**9.1.10** The former subway at Maid Marian Way, Nottingham, was unwelcoming and felt dangerous. When the subway was replaced by an at-grade crossing, the number of pedestrians increased significantly (see Case Study **Chapter 14**).

**9.1.11** More generally, grade separated junctions and links, particularly in urban areas, are rarely successful in placemaking terms. The carriageways have no connection with their surroundings and are highly inflexible and costly to change. Elevated structures create unwelcoming environments at ground level, both beneath and adjacent to the route.



Nechells Parkway, Birmingham - Despite this pedestrian subway being close by, and the absence of a formal surface crossing, many people choose to walk across the central reservation to reach the bus stops.

**9.1.12** The choice of junction and crossing type at a particular location should be made after considering all of its functional requirements - including both movement and place functions - and not just capacity and road safety. Every type of junction has its advantages and disadvantages, and the effect of alternative options should be considered.

**9.1.13** A Quality Audit approach (see **Chapter 4**) can be used to assess alternative junction types and layouts, so that the best balance of outcomes is achieved, taking into account the objectives of the scheme.

## 9.2\_ Spacing of Junctions

**9.2.1** In the past, guidance on minimum junction spacing has often been based on recommended stopping sight distances (SSD) for 85th percentile speeds. The reductions in SSD compared to previous practice means that junction spacing criteria determined on this basis should be reduced. However, in any event there appears to be little evidence that spacing criteria based on SSD are justified on safety or other grounds.



**9.2.2** The need for and provision of junctions on new highways, and additional junctions on existing routes, should be assessed in the round, considering a wide range of factors such as the need for access at particular locations, the impact on the size of development blocks, the potential for interaction between adjacent junctions and the consequent effect on user delay and road safety.

## 9.3\_ Crossings

**9.3.1** General advice on the choice of crossing type and their design is given in Local Transport Notes 1/95<sup>50</sup> and 2/95<sup>51</sup> and in Chapter 6 of MfS1, which is complemented by the further advice in this section. While the focus is on pedestrian crossings the recommendations can also be applied in most instances to crossings designed for cyclists (other than zebra crossings). Crossings should be provided with appropriate tactile paving. The legal requirements for crossings are given in the Crossing Regulations<sup>52</sup>.

**9.3.2** Crossings should be located on or close to desire lines so that pedestrians find them convenient and pleasant to use. Placing crossings away from desire lines will reduce their level of use, even when guardrailling or other deterrent features are used.



Stoke Newington - new zebra crossings and new routes through park, linking directly to one another.

**9.3.3** The simplest form of uncontrolled or informal crossing involves the provision of dropped or flush kerbs so that mobility-impaired people can cross to and from the carriageway. A refuge in the centre of the carriageway enables pedestrians to negotiate one stream of traffic at a time, which can be of considerable help when flows are high. Combining a refuge with a kerb build out, so that the carriageway is narrowed, will provide additional assistance to pedestrians. Further guidance on the design of refuges is given in **Chapter 8**.

**9.3.4** Informal crossings can also indicate clearly to drivers where pedestrians are encouraged - and are therefore likely - to be crossing. Designs can make use of contrasting paving materials, street furniture and changes in carriageway width and level to emphasise pedestrian movement. When done well, in a slow speed traffic environment, they will often encourage drivers to give informal priority to pedestrians.



Shrewsbury High Street – ‘courtesy’ crossings are paved in the same material as the footways and line up with pedestrian routes on either side. See [Traffic Advisory Leaflet 8/98](#)<sup>103</sup>.

**9.3.5** Informal crossings require no signs or markings and therefore do not add to visual clutter. They can be generous in width (to pedestrians) so that the crossing becomes a strong element within the street scene.

**9.3.6** Replacing controlled crossings (ie zebra and signalised) with informal crossings can reduce delays to traffic. In the Newland Avenue MPR scheme all signal-controlled crossings were removed, which resulted in reduced vehicle travel times as well as a reduction in maximum vehicle speed. Road safety and vehicle emissions were also improved significantly - details are given in [LTN 3/08](#)<sup>1</sup>.

**9.3.7** Zebra crossings offer the greatest advantage to pedestrians as they give them priority over all other traffic. In some authorities there has been a move away from providing zebra crossings towards signalised crossings, on the basis that they represent an ‘upgrade’ but this is not necessarily the case. Research carried out in London found that it was not possible to ascribe a safety benefit directly to the conversion of zebra crossings to pelicans<sup>53</sup>.

**9.3.8** Zebra crossings also typically result in lower delays to traffic flow, except when pedestrian flows are heavy. They are more immediately visible to drivers than signalised crossings and can be located closer to junctions, which can help to put crossings on desire lines.



Zebra crossing located close to road junction.

**9.3.9** Zebra crossings are generally only used when the speed limit is 30mph or below, as at higher speeds it may be more difficult for pedestrians to establish precedence.

**9.3.10** There are four types of stand-alone signalised crossings - Pelican, Puffin, Toucan and Equestrian crossings, which are described in [LTN 2/95](#)<sup>51</sup>. Traffic signal junctions can also incorporate signalised crossings.

**9.3.11** Signalised crossings can cause additional delay compared to zebras and informal crossings, due to the lost time caused by intergreen periods etc. Linking signalised crossings to upstream signalised crossings can bring traffic benefits but this can lead to long delays for pedestrians.

**9.3.12** Signalised crossings need to be used when controlled facilities for mounted cyclists and equestrians are required, as these groups are not authorised to use zebra crossings. Older people and people with a visual impairment may express a preference for signalised crossings as they provide greater certainty when crossing.

**9.3.13** All types of crossing can be provided on a raised surface, so that pedestrians cross between footways on a level surface. This slows traffic on the approach to the crossing, makes pedestrians more visible and emphasises their presence in the street, making it more likely that drivers will see them and cede priority.





Zebra crossing on raised table.



Simple raised crossing of minor arm, with tight corner radii.



Signalised crossing on extensive raised table, City of London

**9.3.15** Zebra crossings can also be used across minor junctions close to the give way line, when it is judged desirable to provide clear pedestrian priority at this point.



Zebra crossing across minor arm, close to junction, on desire lines.

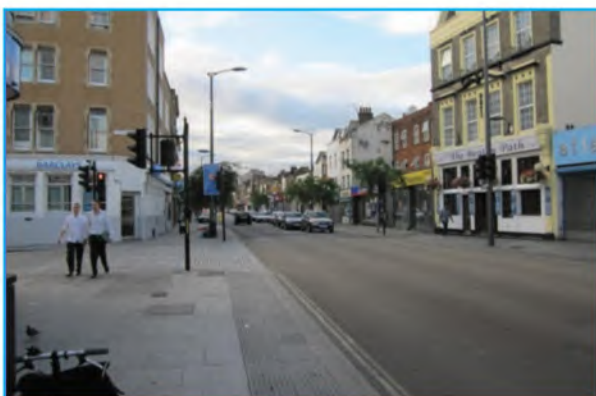

Raised table across side road at signalised crossing – Walworth Road MPR scheme.

**9.3.16** Controlled crossings may be divided using central refuges. Straight ahead divided crossings are much more convenient for pedestrians than staggered crossings, which involve additional delay and deviation from the desire line, particularly where the stagger is large.

**9.3.14** Raised crossings across the mouth of minor road junctions are very helpful to pedestrians, and provide an element of informal priority at this key conflict point. Tight corner radii help to reduce the speed of turning traffic and help make the crossing movements easier and safer. The Highway Code notes (Rule 170)<sup>22</sup> that pedestrians who have started to cross a junction have priority.



Staggered signalised crossing without guardrail



High Street Kensington - replacement of staggered crossing with straight over crossing at signalised junction.

**9.3.17** Divided zebra crossings operate as two separate crossings, with pedestrians having to establish priority on each side. The absence of a stagger does not affect the operation of a zebra crossing in terms of pedestrian priority.

**9.3.18** Signalised crossings that are divided by a refuge, and which are to operate in traffic terms as two separate crossings, are normally staggered, although there are examples of straight ahead signalised crossings that operate under separate phases (see box out on Maid Marian Way, overleaf).

**9.3.19** Pedestrian guardrailing is often used to reinforce staggers, but it is not essential. Some authorities have successfully used upstand kerbs or low walls to define the stagger at signalised crossings, which significantly reduces street clutter.

## Maid Marian Way – Two Stage Straight Ahead Crossings

At the junction of Maid Marian Way and Friar Lane, Nottingham, a roundabout with pedestrian subways was replaced by a signal-controlled junction with pedestrian crossings.



Unwelcoming pedestrian subways were replaced by signal-controlled at-grade crossings.

Maid Marian Way is a busy dual carriageway and both crossings of this route needed to be signalled in two stages. Despite this requirement, straight ahead crossings were used, rather than relying on more conventional staggered layouts. Nearside pedestrian aspects were used, as farside aspects could have led to confusion.

Another non-standard aspect of the design is that one of the crossings is not perpendicular to the traffic flow and stop line, but rather follows the pedestrian desire line.



## 9.4 Priority and Uncontrolled Junctions

**9.4.1** The simplest junctions are where two or more streets meet at a point. These junctions may have marked priority so that there is a major route through the junction, or the junction may have no marked priority and is therefore uncontrolled. Uncontrolled junctions tend to increase driver uncertainty and lead to reduced speeds and are therefore appropriate to low volume and low speed environments, including in urban centres.

Diagonal crossing, Oxford Circus



Diagonal crossing, Balham



**9.3.20** Pedestrian crossings at traffic signals are typically across each arm of the junction, but when an all-red (to traffic) phase is provided, consideration can be given to providing diagonal crossing facilities. These enable pedestrians to cross to the opposite corner of the junction in one movement instead of two, which is much quicker and more convenient. A high-profile scheme has recently been installed at Oxford Circus in London, but there are long-standing examples elsewhere, such as in Balham, at the junction of Bramford Road and Yarmouth Road in Ipswich, and in Wellingborough at the junction of Croyland Road, Dodington Road and Broadway near a school.

**9.4.2** Detailed guidance on the design of priority junctions is given in TD42/95<sup>54</sup> but (as with all sections of DMRB) this is written specifically for trunk roads and, where used in other situations, should not be applied uncritically.

**9.4.3** T and Y junctions have the fewest conflicting traffic movements. Where there is a straight or nearly straight through route drivers will tend to regard this as the major movement, and so even without road markings or signs, a natural priority will tend to develop.

**9.4.4** Crossroads and multi-armed junctions have much higher numbers of conflicting traffic movements and therefore tend to perform worse in terms of road safety. However, grid-type networks with crossroads junctions are extremely legible and therefore encourage walking and cycling, and it is therefore important to strike the right balance. Well-connected street grids can also disperse traffic flows, which will tend to reduce the level of conflict at any particular point.

**9.4.5** Reducing traffic speed will also improve safety, and one way of achieving this at the conflict point is to raise the junction onto a speed table.



Tabled crossroads

**9.4.6** Keeping the number of approach lanes to the minimum will make the junction safer and easier to negotiate for pedestrians and cyclists. Research into cycle safety at T-junctions found that higher cycle collision rates are associated with two lane minor road approaches<sup>55</sup>.

**9.4.7** TD 42/95<sup>54</sup> recommends that consideration should be given to providing a right turning lane at priority junctions where the side road flow exceeds 500 vehicles per day, but this advice relates to trunk roads, where there is an emphasis on providing an unimpeded route for through traffic. It is a relatively low flow, and junctions without right turn lanes will often be able to cater for higher levels of turning traffic without resulting in significant congestion.

**9.4.8** Right turning lanes make it more difficult for pedestrians to cross major roads and lead to higher traffic speeds and authorities should therefore consider carefully

all of the effects before deciding to provide them. Removing unnecessary right turn lanes can also be considered, and will bring substantial benefits to non-motorised users.

**9.4.9** Where right turn lanes are to be provided or retained, refuges should be provided within ghost islands to facilitate pedestrians crossing.

**9.4.10** As noted in Sections 6.3 and 6.4 of MfS1, tight corner radii help pedestrians and cyclists to travel across and through junctions by reducing the speed of turning



Ghost island junction with pedestrian refuge

vehicles. Advice contained in TD 42/95<sup>54</sup>, that minimum corner radii should be 6m in urban areas, should therefore not be taken as representing best practice when the needs of vulnerable road users are to be prioritised.

**9.4.11** Larger vehicles can still negotiate junctions where minimal (1m or less) corner radii are used, depending on the width of the junction arms they are turning to and from. In many cases it will be better to have slightly greater carriageway widths at the junction, rather than generous corner radii, or accept that larger vehicles occasionally cross into the opposing lane. This approach allows the vehicle to take a larger radius than the junction kerb, as shown below. This can be tested by vehicle tracking software rather than relying on fixed standards.

**9.4.12** Designers are sometimes reluctant to use tight corner radii on the grounds that vehicles slowing to turn into the minor arm may cause shunt collisions on the

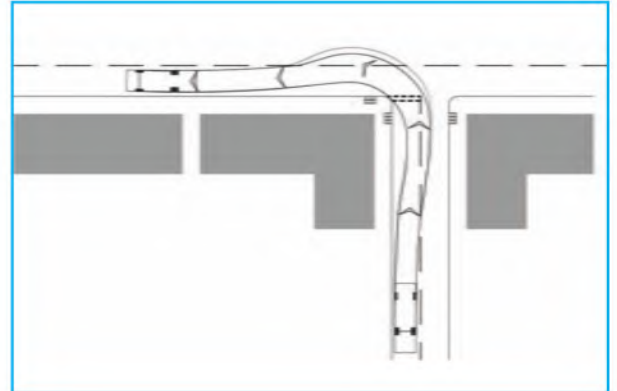

Despite the small corner radius, with sufficient carriageway width (X) a long vehicle can still negotiate a junction.

major road. This may be the case where speeds are high, but in urban areas the overall emphasis of MfS is that speeds should be reduced to appropriate levels of 30mph or below through design and the use of tight corner radii is consistent with this approach.

**9.4.13** Moreover, there are junctions on very busy routes where tight corner radii have existed for a considerable time, as shown above.



**9.4.14** Footway crossovers can be used instead of more formal priority junctions, which will give further prominence to pedestrians. Footway crossovers are often used successfully at accesses to commercial premises, as illustrated below, demonstrating that they can be used at busy locations.

**9.4.15** Footway crossovers should maintain the normal footway cross-fall as far as practicable from the back of the footway (900mm), as recommended in MfS1. Designs

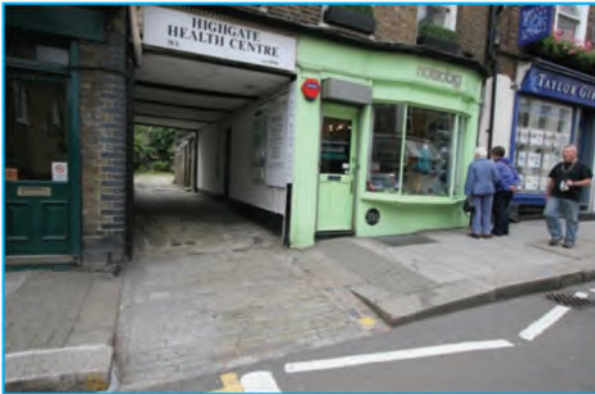

Footway crossover access to commercial premises

which ramp up over the whole width of the footway make it difficult for people with a mobility impairment, including wheelchair users, to negotiate the crossover.

**9.4.16** The safety aspects of visibility requirements at priority junctions are dealt with in **Chapter 10**. Junction capacity is also dependent on visibility, however, as the drivers on the minor arm will emerge more cautiously and slowly when visibility is limited. Standard junction capacity tools such as PICADY enable designers to consider the effect of minor road visibility on junction capacity.

## 9.5\_ Squares

**9.5.1** Squares are excellent opportunities for creating successful and attractive public spaces, where people will wish to spend time, and are natural sites for commercial and public buildings that add to vitality. Many towns and cities have public squares at their heart, and many designs for urban extensions incorporate public squares as a focal point for the new community.

**9.5.2** Although squares are primarily regarded as public spaces, squares with traffic passing through them can also be regarded as a development of priority and/or uncontrolled junctions. Squares offer a good way of enabling complex turning movements to take place across a more dispersed area, rather than at a single point, thus reducing conflict and improving safety. Many squares successfully incorporate car parking within the space.



Poundbury, Dorset. This square, where four routes meet, forms part of a new urban extension. It includes parking and local shops

## 9.6\_ Conventional Roundabouts

**9.6.1** Conventional roundabouts are widely used in the UK. Detailed guidance on the design of roundabouts is given in TD16/07<sup>56</sup> but (as with all sections of DMRB) this is written specifically for trunk roads and, where used in other situations, should not be applied uncritically.

**9.6.2** Roundabouts typically have the lowest rate and severity of motor vehicle collisions and cause low levels of traffic delay, and therefore reduced vehicle emissions, in off-peak conditions. They can deliver high levels of traffic capacity and can cater for junctions with more than four approach arms, although there is some evidence that this can lead to a reduction in road safety.

**9.6.3** On the other hand, roundabouts generally have a poor collision record for cyclists and can be a significant barrier to pedestrian movement. Many roundabout designs make only minimal provision for pedestrians, requiring them to cross wide entry and exit arms. Where formal crossings are installed, whether as zebra or signal-controlled crossings, they are often placed well away from desire lines. Some designers have created subways beneath roundabouts in an attempt to give pedestrians more direct crossing routes, but as the Maid Marian Way Case Study shows, this has rarely been successful (**Chapter 14**).

**9.6.4** Providing adequate deflection is important in reducing speed for motor vehicles, and normal practice is for the geometry to force vehicles to turn through a curve of less than 100m in radius. This is less important in urban areas with a speed limit of 30mph or below where speed can be limited by other means. Designs that use means other than deflection to achieve low speeds can also have a good safety record.

**9.6.5** Roundabouts can have a large land requirement and their circular geometry does not sit comfortably in dense urban areas. The signs and road markings generally associated with roundabouts can be very intrusive, although advice is given in **Chapter 13** on how this can be minimised.

**9.6.6** When roundabouts are proposed, the recommended approach is to make the overall diameter of the junction as compact as possible to minimise land take. This will reduce the disruption to pedestrian desire lines, with crossings placed close to entries and exits. This may have some impact on traffic flow, but this should not always be seen as an unacceptable outcome, given the underlying need to encourage walking and cycling. Placing crossings on pedestrian desire lines will avoid the need for guardrailling.

**9.6.7** Entries, exits and circulatory carriageways should be as narrow as possible, ideally to a single lane, subject to capacity considerations. UK practice has generally been to have generous entry and exit radii and avoid re-entrant curves, but moving towards a more 'continental' or 'compact' geometry will result in slower traffic speeds on the entries, exits and circulatory carriageway, which will be of benefit to cyclists and pedestrians.

**9.6.8** Compact roundabouts are recommended in TD16/07<sup>56</sup> for single carriageway roads, and are particularly suitable where there is a need to accommodate the movement of pedestrians and cyclists. Further guidance on providing for cyclists at compact roundabouts is given in Traffic Advisory Leaflet (TAL) 9/97<sup>57</sup>.

**9.6.9** The widths of circulatory carriageways should be checked using swept path analysis, considering the largest vehicle that will regularly negotiate the junction, rather than always designing for the largest legal articulated vehicle, and using predetermined widths based simply on diameter. This may well allow smaller roundabouts to be achieved, particularly in urban areas.

**9.6.10** Roundabouts do not always have to be circular, and ovoid or less regular shapes can be used in constrained situations. Care should be taken however to avoid sharp curves which can result in an overturning hazard for long vehicles.

**9.6.11** Left turn slip lanes are often used to increase traffic capacity when there is a heavy demand for this movement. These create a particular hazard for cyclists, however, when they are leaving the circulatory carriageway and find themselves between two moving traffic lanes. Designers should not use these designs without resolving this problem satisfactorily.



Cyclists leaving this roundabout can find themselves in the outside lane of a dual carriageway.

**9.6.12** Central islands at roundabouts can be utilised as sites for public art and monuments, but this is likely to be much more successful when these sites can be reached and enjoyed by people on foot.



Although the Wellington Arch, London is situated on a large roundabout, the direct crossing facilities mean that it is accessible by people on foot, cycle and on horses.



The monument at Seven Dials, London, acts as a place to sit and linger, as well as a place to move through and is a public square where seven routes meet. Roundabout priority is established by the placing of signs only on the entries to the junction.

## 9.7\_ Mini-Roundabouts

**9.7.1** Mini-roundabouts are essentially the application of a road marking (TSRGD diag 1003.4)<sup>58</sup> which defines a give-way to the right rule, circulating the marked central island. Detailed guidance is given in TD 54/07<sup>59</sup> but (as with all sections of DMRB) this is written specifically for trunk roads and, where used in other situations, should not be applied uncritically.

**9.7.2** In particular, although TD 54/07 states that new mini-roundabouts are not to be used at new junctions on trunk roads, no such presumption applies elsewhere, and mini-roundabouts remain a valid choice of junction type for new as well as existing junctions.

**9.7.3** Further detailed guidance on the design of mini-roundabouts is given in the DfT and County Surveyors' Society (now ADEPT) publication 'Mini roundabouts good practice guidance'<sup>60</sup>.

**9.7.4** Many mini-roundabouts have been installed at existing junctions where they can bring advantages such as the reduction in traffic speed on all approaches and a reduction in overall traffic delay. The land requirement of this type of junction is small - they can be fitted into junctions with an overall diameter of around 12m or less and thus create little diversion for pedestrians. They are safer for cyclists than large conventional roundabouts.



This mini-roundabout has an overall diameter of around 12m. It was installed as part of a village traffic calming scheme and has resulted in a significant reduction in collisions.

**9.7.5** Mini-roundabouts cannot easily achieve good entry deflection and so are only suitable in locations where approach speeds are 30mph or below. One way of achieving a slow approach speed is to raise the junction on a table.

**9.7.6** Most designs are unlikely to deliver high traffic capacities; mini-roundabouts with multiple approach lanes have been used but these are less easy for pedestrians and cyclists to negotiate safely, and can lead to higher approach speeds.

**9.7.7** Mini-roundabouts work best where the traffic flow on different arms is reasonably balanced, so that drivers on all approaches slow down in anticipation of having to give way. When one or more arms has a relatively light traffic flow, a means of reducing traffic speeds, such as placing the junction on a speed table, may be a solution.

**9.7.8** The requirements for road markings and signs at mini-roundabouts do have a considerable visual impact and can be particularly intrusive.

**9.7.9** Some authorities have responded to this by installing junctions that are designed to encourage drivers to adopt circulatory priority, but they are in fact uncontrolled junctions - see Example of Julian Road, Bath, overleaf.





Julian Road Bath – Before and After

The scheme involved the redesign and realignment of a stretch of busy road outside a primary school in the west of Bath between Marlborough Street and the junction with Harley Street. A ghost island junction was replaced by an uncontrolled junction that used pavement materials to encourage circulatory priority.

In the three years prior to the scheme, there were nine recorded serious accidents in the relevant area, including one fatality. There have been no recorded accidents in the three years since the scheme was completed. The scheme included removal of most signs, barriers and road markings, and the creation of simple informal “places” instead of sweeping priority junctions.

**9.7.10** Mini-roundabouts can also have controlled crossings close to exits, on pedestrian desire lines.



Zebra crossing close to mini-roundabout exit.

**9.8.2** Traffic signals are widely used in urban situations and in rural locations and can cater for high traffic flows, although they are less appropriate than roundabouts when approach speeds are high. They generally have a worse road safety record than roundabouts in terms of vehicle-vehicle collisions, but are better suited to accommodate pedestrians and cyclists on their desire lines, although less so as the size and complexity of the junction increases.

## 9.8\_ Traffic Signals

**9.8.1** The principles of traffic signal control are set out in TAL 01/06<sup>61</sup> and the design of pedestrian facilities at signals is covered by TAL 05/05<sup>62</sup>. Detailed guidance is given in TD 50/04<sup>63</sup> but (as with all sections of DMRB) this is written specifically for trunk roads and, where used in other situations, should not be applied uncritically.



Traffic signal junction with clear and simple pedestrian crossings and advance cycle stop lines. Note lack of guardrailing and buildings close to junction corner, and tight corner radii.

**9.8.3** Traffic signals add to street clutter, particularly layouts that require large numbers of signal heads and other equipment. They can therefore have a severe visual impact. The minimum number of signals at crossings is specified in the Schedule to Direction 54 of TSRGD<sup>58</sup>. For example, a non-staggered crossing only requires one primary and one secondary signal. Straight ahead crossings generally require fewer signal heads and therefore create less clutter.



Traffic signals can have a severe visual impact

**9.8.8** Many traffic signal layouts include segregated left turn lanes, which may be signal-controlled or operate as give way junctions. Whilst they can increase capacity, they make pedestrian crossing movements much more difficult, adding an extra crossing which can significantly increase overall crossing times. They also add to the number of signal heads needed, and therefore clutter. These disbenefits should be expressly considered before this type of layout is adopted.



Segregated left turn lanes make pedestrian crossing movements more complex and slow, as well as adding to clutter.

**9.8.4** Traffic signals generally occupy less land take than roundabouts, depending on the number of approach lanes and the need for separate turning lanes.

**9.8.5** Even where it is judged that pedestrian phases at traffic signals are not justified, pedestrians can still cross more easily at traffic signals than at other locations, when traffic streams are stopped by red signals or during intergreen periods.

**9.8.6** As with priority junctions, tight corner radii will make it easier for pedestrians to cross and will reduce the speed of turning traffic, although this will also reduce saturation flows and will need to be taken into account in capacity assessments.

**9.8.7** Visibility requirements between arms of traffic signals as set out in TD 50/04<sup>63</sup> may affect the ability to position buildings close to the corners of traffic signal junctions, which can affect the ability to create a well-enclosed space. Reducing corner radii can enable stop lines to be brought forward to reduce this effect, but designers may need to consider whether the strict application of these visibility requirements is always appropriate, particularly in urban situations where speeds are low; or where stop lines are set back considerable distances due to swept path requirements or other reasons, giving rise to large intervisibility zones.

**9.8.9** Traffic signal junctions in urban areas should generally incorporate advanced cycle stop lines to which enable cyclists to position themselves at the head of traffic streams where they are more visible and safer.

**9.8.10** Outside peak hours traffic signals can cause greater levels of delay to all road users than other types of junction, due to the time lost when changing between signal stages. Keeping the number of signal stages to a minimum will reduce this disbenefit. Some authorities have begun to experiment with the removal of traffic signal control to reduce delays, and research studies have found this can lead to significant economic benefits<sup>64</sup>.

**9.8.11** Notwithstanding these potential benefits, care needs to be taken that the removal of traffic signals does not worsen road safety, or make conditions worse for pedestrians and cyclists.

**9.8.12** Traffic signal controllers should be sited to allow unimpeded use of the footway by pedestrians. In the example below, a signal controller has been installed in a bench.



Bench containing traffic signal controller

**9.8.13** Most highway authorities specify backing boards with white borders to traffic signals, but they are not legally required. Local Transport Note 1/98<sup>65</sup> notes that backing boards may be omitted at urban sites where speeds are low and there are no distracting backgrounds.



Signalised crossing with no white borders to signal heads

## 9.9\_ Traffic Management and One-Way Systems

**9.9.1** In many towns and cities traffic management systems, often involving networks of one-way streets, have been created. The usual aim of these systems is to increase network capacity by simplifying turning movements at junctions. These aims are understood, but the improvements in traffic flow capacity are offset by reductions in legibility and accessibility for all road users. One-way streets also tend to cause higher traffic speeds.

**9.9.2** Cyclists are particularly disadvantaged by such systems, since the additional travel distance can be significant. Pedestrians can become disorientated by one-way streets, and fail to look for traffic in the correct direction before crossing. This is a particular problem where there are contraflow bus lanes.

**9.9.3** However, with appropriate designs to minimise vehicle speeds, one-way streets can result in narrower carriageways which can create more space for pedestrians, cyclists and the public realm.

**9.9.4** Some towns and cities have begun to simplify traffic management systems, judging that the benefits to other road users outweighs any additional travel time for motor vehicles. In South Kensington (see overleaf) a complex one-way system has been removed, whilst at the same time considerable areas of carriageway space have been given over to pedestrians.



Before



After

Changes at South Kensington - a complex one-way system has been simplified



Before

Area outside Underground station



After

## 9.10\_ Direct Frontage Access

**9.10.1** Providing direct access to buildings and public spaces is an important element in creating streets that are linked to their surroundings, rather than simply being conduits for passing traffic. Access is a key part of the place function of streets and should be facilitated where possible.

**9.10.2** MfS1 referred to research which looked at the relationship between traffic flow and road safety on streets with direct frontage access to dwellings (MfS1 7.9.5). A limit of 10,000 vehicles per day (vpd) was advised, but this related to the limited number of sites considered with more than this level of traffic, rather than an indication that road safety declines above this level of flow.

**9.10.3** Research referred to in TD 41/95<sup>3</sup> examined the relationship between access frequency and collisions on 3,000km of all-purpose trunk roads in England, both urban and rural, dual and single carriageway. The research showed that there was no simple statistical relationship between the number of collisions and the number of vehicular connections in the form of minor junctions and direct accesses.

**9.10.4** For rural roads, there was a statistically significant relationship between collisions and traffic flow, link length and the total number of all access connections. In the case of urban roads, however, only traffic flow had a significant effect on the number of collisions at this level of confidence, and was found no direct relationship between access provision and collision occurrence.

**9.10.5** It is therefore clear that the advice given in MfS1 concerning direct access is applicable to all urban roads, and that providing direct frontage access is unlikely to have significant disbenefits in road safety terms.



## 10\_Visibility

### 10.1\_Introduction

**10.1.1** This section of MfS2 incorporates Section 7.5 of MfS1. It is based on a combination of the research carried out by TRL<sup>23</sup>, the research carried out by TMS Consultancy for MfS2<sup>66</sup>, a review of recent research and international standards and the outcome of public inquiries since MfS1 was published (see Example below).

**10.1.2** Sight distance parameters can be based on various models, such as stopping sight distance, overtaking distance or gap acceptance. UK practice generally focuses on Stopping Sight Distance (SSD). The effect of sight distance on the capacity of priority junctions is discussed in **Chapter 9** above.

**10.1.3** This section provides guidance on SSDs for streets where 85th percentile speeds are up to 60 kph (37mph). This will generally be achieved within 30mph limits and may be achieved in some 40mph limits.



Inspectors at public inquiries have accepted that SSD guidance in MfS1 applies to non-residential streets. At an appeal into a development of some 100 dwellings, accessed from the B5215 Leigh Road in Wigan, the Inspector concluded that MfS1 did apply, notwithstanding the volume of traffic (approximately 1,700vph peak times) or the classification of the highway (part of the Strategic Route Network).

**10.1.4** Stopping sight distance (SSD) is the distance drivers need to be able to see ahead and they can stop within from a given speed. It is calculated from the speed of the vehicle, the time required for a driver to identify a hazard and then begin to brake (the perception-reaction time), and the vehicle's rate of deceleration. For new streets, the design speed for the location under consideration is set by the designer. For existing streets, the 85th percentile wet-weather speed is used.

**10.1.5** The basic formula for calculating SSD (in metres) is:

$$SSD = vt + v^2/2(d+0.1a)$$

where:

$v$  = speed (m/s)

$t$  = driver perception-reaction time (seconds)

$d$  = deceleration (m/s<sup>2</sup>)

$a$  = longitudinal gradient (%)

(+ for upgrades and - for downgrades)

**10.1.6** The Desirable Minimum SSDs in general use prior to MfS1 were based on a driver perception-reaction time of 2 seconds and a deceleration rate of 2.45 m/s<sup>2</sup> (equivalent to 0.25g, where  $g$  is acceleration due to gravity (9.81 m/s<sup>2</sup>)). The Absolute Minimum SSD values kept the same reaction time of 2 seconds, but assumed a deceleration rate of 3.68 m/s<sup>2</sup> (0.375g).

**10.1.7** The SSD values recommended in MfS1 were based on a perception-reaction time of 1.5 seconds and a deceleration rate of 0.45g (4.41 m/s<sup>2</sup>). This value is appropriate for cars and other light vehicles, but heavy goods vehicles and buses have different deceleration characteristics. When deciding whether to carry out separate checks for cars, HGV and bus SSDs, highway authorities should consider the following factors:

- Volume of HGVs and buses
- Proportion of HGVs and buses
- Presence of priority lanes which may enable higher bus/HGV speeds

**10.1.8** As a guide, it is suggested that bus/HGV SSD should not need to be assessed when the combined proportion of HGV and bus traffic is less than 5% of traffic flow, subject to consideration of local circumstances.

**10.1.9** Based on international vehicle standards (see Example) HGVs must be able to achieve peak deceleration rates of at least 0.509g. However, allowing for the delay in the maximum effectiveness of air braking systems, overall minimum stopping distances are also specified which reduce the minimum overall deceleration rate<sup>A</sup> under the regulations to some 0.36g. Real life tests carried out by ROSPA (also see Example) indicate that these values are likely to be exceeded in practice and therefore the pre-MfS1 Absolute Minimum value of 0.375g is recommended for HGVs. These average deceleration rates already allow for the time taken for air braking systems to apply and therefore the same reaction time of 1.5 seconds should be used.

**10.1.10** For buses, the limiting design factor is passenger comfort and safety rather than the ability of the vehicle to stop, and therefore for buses, the recommended maximum deceleration rate is the same as the pre-MfS1 Absolute Minimum value of 0.375g, as used for the pre-MfS1 Absolute Minimum SSD values.

<sup>A</sup> The minimum overall deceleration rate means the deceleration rate, expressed as a uniform value, from the instant when the brakes begin to be applied when the vehicle stops, required by the standards.

**10.1.11** Where designers wish to determine different SSD values for HGVs and buses it will be necessary to use appropriate design speeds for these classes of vehicle. Where SSD is being calculated for existing highways, actual 85th percentile values for these types of vehicles should be measured and the worst case SSD be used for horizontal measurements of visibility.

**10.1.12** Based on free flow vehicle speeds travelling in 30mph limits given in Transport Statistics Bulletin 2008<sup>45</sup>, buses travel at 90% of the average speed for all vehicles.

### HGV Braking Performance

Minimum standards for lorry braking systems are set out in the UNECE Vehicle Regulation 13<sup>67</sup>, which requires that the mean fully developed deceleration rate achieved by the braking system (with the engine disconnected) should be at least 5.0m/s<sup>2</sup> (0.509g). In addition, the stopping distance of the vehicle must be no more than  $0.15v+v^2/130$ , where v=vehicle speed in kph (up to 60kph), and  $0.15v+v^2/103.5$  (v up to 90kph).

At 50kph the maximum allowable stopping distance is therefore 26.7m, and this is equivalent to a minimum overall braking rate of 3.6m/s<sup>2</sup> or 0.37g.

A series of real life braking tests were carried out by ROSPA using a wide range of vehicles in 2001, as reported in

<http://www.rosipa.com/RoadSafety/AdviceAndInformation/Driving/hgv-truck-braking-systems.aspx>

Deceleration rates have been calculated from the results of these tests which show that the minimum overall braking rate achieved was 0.44g, for a 36 tonne Foden vehicle, which stopped in 20.68m from 30mph. (One vehicle did take longer to stop, at 27m, but this was on a down slope). Cars were also tested by ROSPA, and the best performing of these was a Ford Mondeo, which stopped from 30mph in 7.14m, an overall deceleration rate of 1.27g.

**10.1.13** In summary, recommended values for reaction times and deceleration rates for SSD calculations are given in **Table 10.1** below and the resulting SSD values for initial speeds of up to 120kph are shown on the graph beneath.

Design Speed	Vehicle Type	Reaction Time	Deceleration Rate	Comments
60kph and below	Light vehicles	1.5s	0.45g	
	HGVs	1.5s	0.375g	See 10.1.9
	Buses	1.5s	0.375g	See 10.1.10
Above 60kph	All vehicles	2s	0.375g (Absolute Min SSD)	As TD 9/93
	All vehicles	2s	0.25g (Desirable Min SSD)	As TD 9/93

**Table 10.1:** Summary of Recommended SSD Criteria

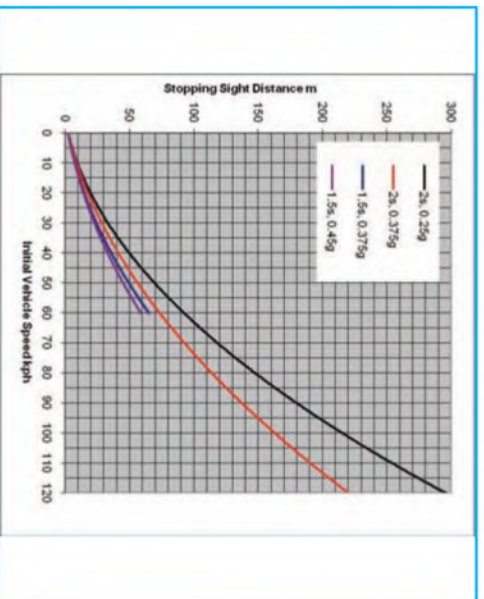

Graph showing recommended SSD values, allowing for bonnet length.

## 10.2\_Visibility Requirements

**10.2.1** Visibility should be checked at junctions and along the street. Forward visibility is measured horizontally and vertically.

**10.2.2** Using plan views of proposed layouts, checks for visibility in the horizontal plane ensure that views are not obscured by vertical obstructions.

**10.2.3** Checking visibility in the vertical plane is then carried out to ensure that views in the horizontal plane are not compromised by obstructions such as the crest of a hill, or a bridge at a dip in the road ahead. It also takes into account the variation in driver eye height and the height range of obstructions. Eye height is assumed to range from 1.05m (for car drivers) to 2m (for bus and HGV drivers).

**10.2.4** Drivers need to be able to see obstructions from 2m high down to a point 600 mm above the carriageway. The latter dimension is used to ensure small children can be seen.

**10.2.5** The SSD figure relates to the position of the driver. However the distance between the driver and the front of the vehicle is typically up to 2.4m, which is a significant proportion of shorter stopping distances. It is therefore recommended that for assessments of SSD, an allowance is made by adding 2.4m to the distance calculated using the formula.

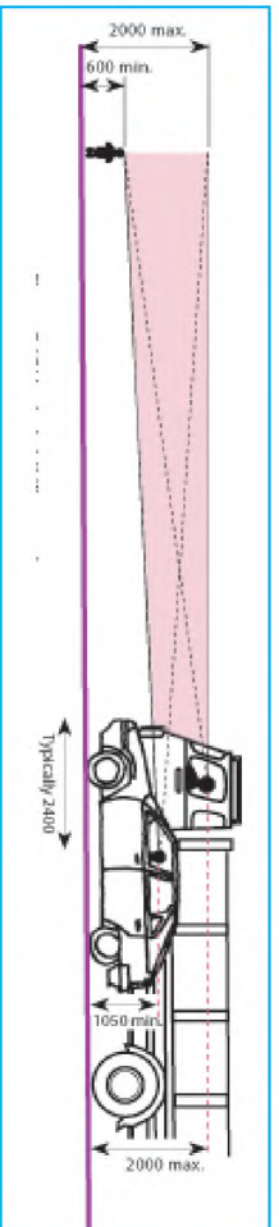

## 10.3\_Forward Visibility

**10.3.1** The minimum forward visibility required is equal to the minimum SSD, based on the design speed at the location being considered. It is checked by measuring between points on a curve along the centreline of the inner traffic lane (see Fig.10.1).

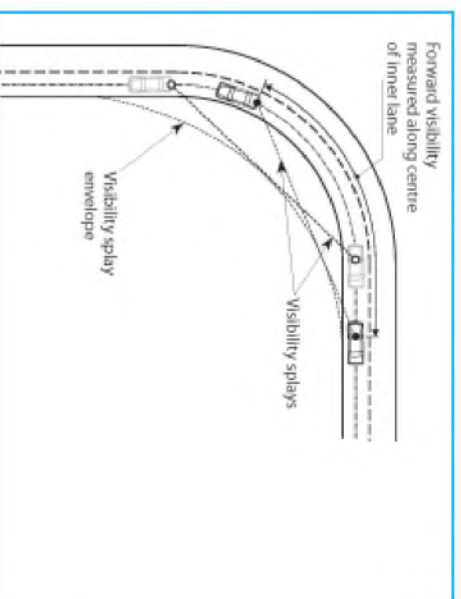

Figure 10.1 - Measurement of forward visibility

**10.3.2** However there will be situations in locations with design speeds of 60kph or less where it is desirable and appropriate to restrict forward visibility to control traffic speed - research carried out for M/S1 describes how forward visibility influences speed. An historic example is shown below.



Spaniards Inn, Hampstead – historic building restricting forward visibility and carriageway width



## 10.4\_ Visibility At Priority Junctions

**10.4.1** The visibility splay at a junction ensures there is adequate inter-visibility between vehicles on the major and minor arms.

**10.4.2** It has often been assumed that a failure to provide visibility at priority junctions in accordance with the values recommended in MfS1 or DMRB (as appropriate) will result in an increased risk of injury collisions. Research carried out by TMS Consultancy for MfS2<sup>66</sup> has found no evidence of this (see research summary below). Research into cycle safety at T-junctions found that higher cycle collision rates are associated with greater visibility<sup>55</sup>.

### High Risk Collision Sites and Y Distance Visibility

#### Introduction

The accepted approach to visibility at priority junctions has been to provide a minimum stopping sight distance value appropriate to a particular design speed. The assumption made by some designers and road safety auditors is that this value provides a minimum road safety requirement, and that collision risk will increase if the SSD is not achieved.

The purpose of this research was to examine this assumption and to identify whether or not a direct relationship can be established between variations in Y distance SSD and collision frequency at priority junctions.

#### Methodology

##### Site Selection

A series of “high risk” priority junctions was identified as the basis for research. Uncontrolled crossroads and T- junctions were selected for all classes of road throughout all 20, 30 and 40mph speed limits in Nottinghamshire, Sandwell, Lambeth, and Glasgow. For each area a list of all non-pedestrian collisions was ranked in descending order of collision total for a recent five-year period, with over 1500 collisions listed in total. Each location was then analysed in detail to identify specific collision characteristics.

##### Collision Analysis

Collisions involving vehicles emerging from junctions into the path of vehicles on the main road, together with nose-to-tail shunts on the minor road were identified as the type of incident that could have been caused by “poor visibility”. The locations were then ranked in descending order of these types of crashes, and site visits were carried out at the “worst” sites.

In addition to the 626 potential “poor visibility” collisions, a record was made of 203 collisions involving main road shunts, 46 collisions involving main road bus passengers, 22 collisions involving main road large goods vehicles, and 216 collisions involving main road two-wheeled vehicles. There is a concern that these types of collisions could be over-represented at locations with poor visibility.

##### Site Visits

Two investigators visited each location, and measured visibility to the left and right, from a point on the side road, 2.4m back from the main road channel line. Visibility was measured from a height of 1.05m, to a point at the kerb edge and a second point 1m out from the kerb edge, where observations showed that visibility increased.

### Summary of Findings

- “High risk” sites were defined as locations that had three or more potential poor visibility collisions - in a five year period (94 in total). Of these 90 were on 30mph roads, with 3 on 40mph roads. At 55 of the 94 locations the worst case visibility (either to the left or right) was restricted to less than 120m. Thus in relation to the total number of uncontrolled junctions that exist, the proportion of “high risk” sites where visibility is less than that recommended for 70kph in DMRB is likely to be very low. It is possible that some former high risk priority junctions have been converted to other forms of junction control.
- In two thirds of the cases where visibility was less than 120m, the restriction was due to parked vehicles or street furniture. It is not possible to determine whether the parking was present at the time of the collision.
- Linear regression to compare potential poor visibility collisions with Y distance has a very low R<sup>2</sup> value, which shows that the variation in collision frequency was explained by factors other than Y distance visibility, for a large number of different situations. Therefore Y distance cannot be seen as a single deterministic factor at these high-risk collision locations (see example graph below).

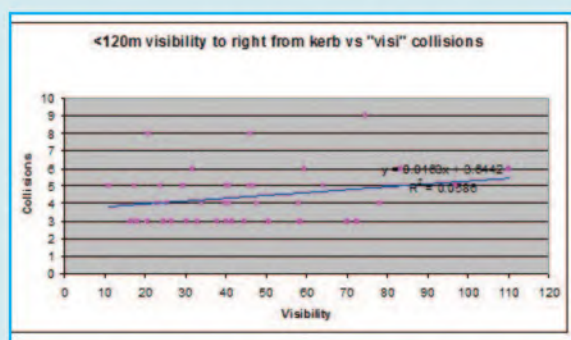

Visibility measured to right, to nearside kerb.

	No. of sites	No. collisions	Collisions per year	Collisions per site per year
0-20m	4	16	3.2	0.80
20-40m	14	58	11.6	0.83
40-60m	15	64	12.8	0.85
60-80m	5	24	4.8	0.96
80-100m	2	11	2.2	1.10
100-120m	1	6	1.2	1.20
120m+	48	208	41.6	0.87

- A series of collision types at high risk locations where Y distance was less than 45m were compared with locations with more than 45m visibility. There were no statistically significant differences between the two sets of data. The data analysed included main road bus and large goods vehicle collisions, and the research did not find high numbers of collisions involving these types of vehicles at low visibility sites.

Collision type	No & % in sites <45m vis	No & % in sites >45m vis
Potential visi collisions in dark	40 (31.75%)	90 (30.3%)
Main road shunts	24 (8.79%)	50 (9.11%)
Bus passenger	10 (3.66%)	10 (1.82%)
Main road HGV	1 (0.37%)	5 (0.91%)
Main road two-wheeled.	38 (13.92%)	85 (15.58%)

### Conclusions

- This study has been unable to demonstrate that road safety concerns regarding reduced Y distance are directly associated with increased collision risk at “high-risk” urban sites;
- Previous research for MfS1 demonstrated that main road speed is influenced by road width and forward visibility. Many of the locations in this study were straight roads with good forward visibility. The ability of the driver to stop is likely to be affected by more than just what is happening in the side road and an understanding of the factors influencing main road speed is important when assessing visibility requirements.

## 10.5\_ X and Y Distances

### Measurement of X and Y distances

**10.5.1** The distance back along the minor arm from which visibility is measured is known as the X distance (Figure 10.2). It is generally measured back from the 'give way' line (or the main road channel line if no such markings are provided).

**10.5.2** This distance is normally measured along the centreline of the minor arm for simplicity, but in some circumstances (for example where there is a wide splitter island on the minor arm) it will be more appropriate to measure it from the actual position of the driver.

**10.5.3** The Y distance represents the distance that a driver who is about to exit from the minor arm can see to the left and right along the main alignment. For simplicity it has previously been measured along the nearside kerb line of the main arm, although vehicles will normally be travelling at a distance from the kerb line. Therefore a more accurate assessment of visibility splay is made by measuring to the nearside edge of the vehicle track. The measurement is taken from the point where this line intersects the centreline of the minor arm (unless, as above, there is a splitter island in the minor arm).

**10.5.4** When the main alignment is curved and the minor arm joins on the outside of a bend, another check is necessary to make sure that an approaching vehicle on the main arm is visible over the whole of the Y distance. This is done by drawing an additional sight line which meets the kerb line at a tangent.

**10.5.5** Some circumstances make it unlikely that vehicles approaching from the left on the main arm will cross the centreline of the main arm - opposing flows may be physically segregated at that point, for example. If so, the visibility splay to the left can be measured to the centreline of the main arm.

### Recommended values for X and Y distances

**10.5.6** An X distance of 2.4m should normally be used in most built-up situations, as this represents a reasonable maximum distance between the front of a car and the driver's eye.

**10.5.7** Longer X distances enable drivers to look for gaps as they approach the junction. This increases junction capacity for the minor arm, and so may be justified in some circumstances, but it also increases the possibility that drivers on the minor approach will fail to take account of other road users, particularly pedestrians and cyclists. Longer X distances may also result in more shunt collisions on the minor arm. TRL Report No. 184<sup>68</sup> found that collision risk increased with greater minor-road sight distance.

**10.5.8** A minimum X distance of 2m may be considered in some slow-speed situations when flows on the minor arm are low, but using this value will mean that the front of some vehicles will protrude slightly into the running carriageway of the major arm, and many drivers will tend to cautiously nose out into traffic. The ability of drivers and cyclists to see this overhang from a reasonable distance, and to manoeuvre around it without undue difficulty, should be considered. This also applies in lightly-trafficked rural lanes.

**10.5.9** The Y distance should be based on the recommended SSD values. However, based on the research referred to above, unless there is local evidence to the contrary, a reduction in visibility below recommended levels will not necessarily lead to a significant problem.

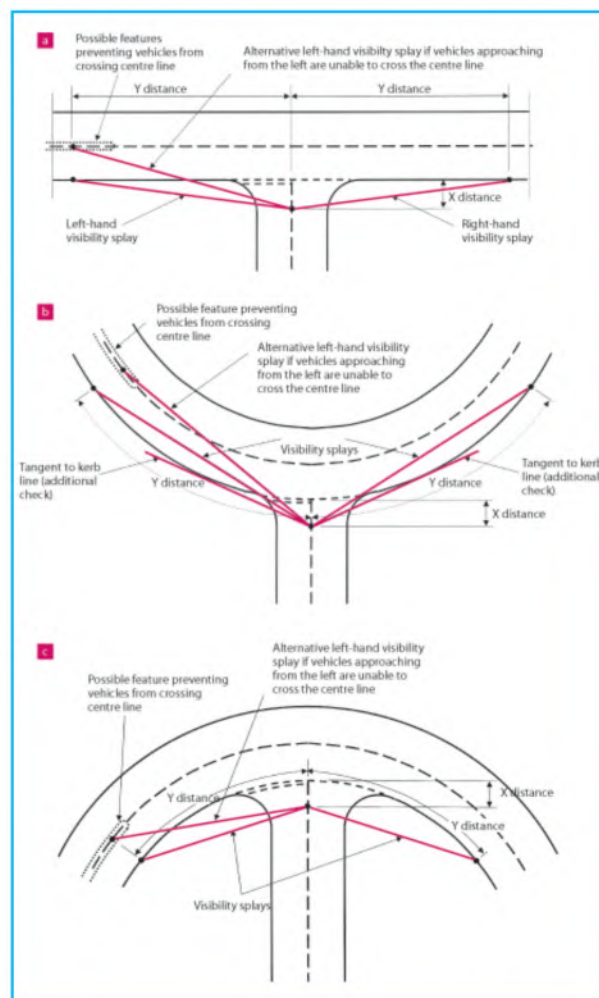

Figure 10.2

## 10.6\_ Visibility Along The Street Edge

**10.6.1** Vehicle exits at the back edge of the footway mean that emerging drivers will have to take account of people on the footway. The absence of wide visibility splays at minor accesses will encourage drivers to emerge more cautiously - similarly to how vehicles pull out when visibility along the carriageway is restricted (see Example below)

**10.6.2** . Consideration should be given to whether this will be appropriate, taking into account the following:

- the frequency of vehicle movements;
- the amount of pedestrian activity; and
- the width of the footway.

**10.6.3** When it is judged that footway visibility splays are to be provided, consideration should be given to the best means of achieving this in a manner sympathetic to the visual appearance of the street (**Figure 10.3**). This may include:

- the use of boundary railings rather than walls; and
- the omission of boundary walls or fences at the exit location.

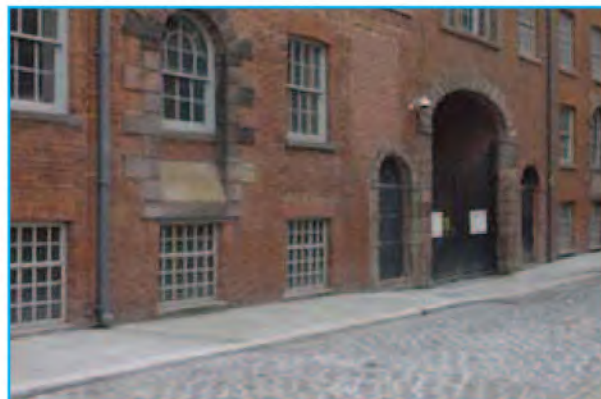

Access to commercial property with limited visibility.

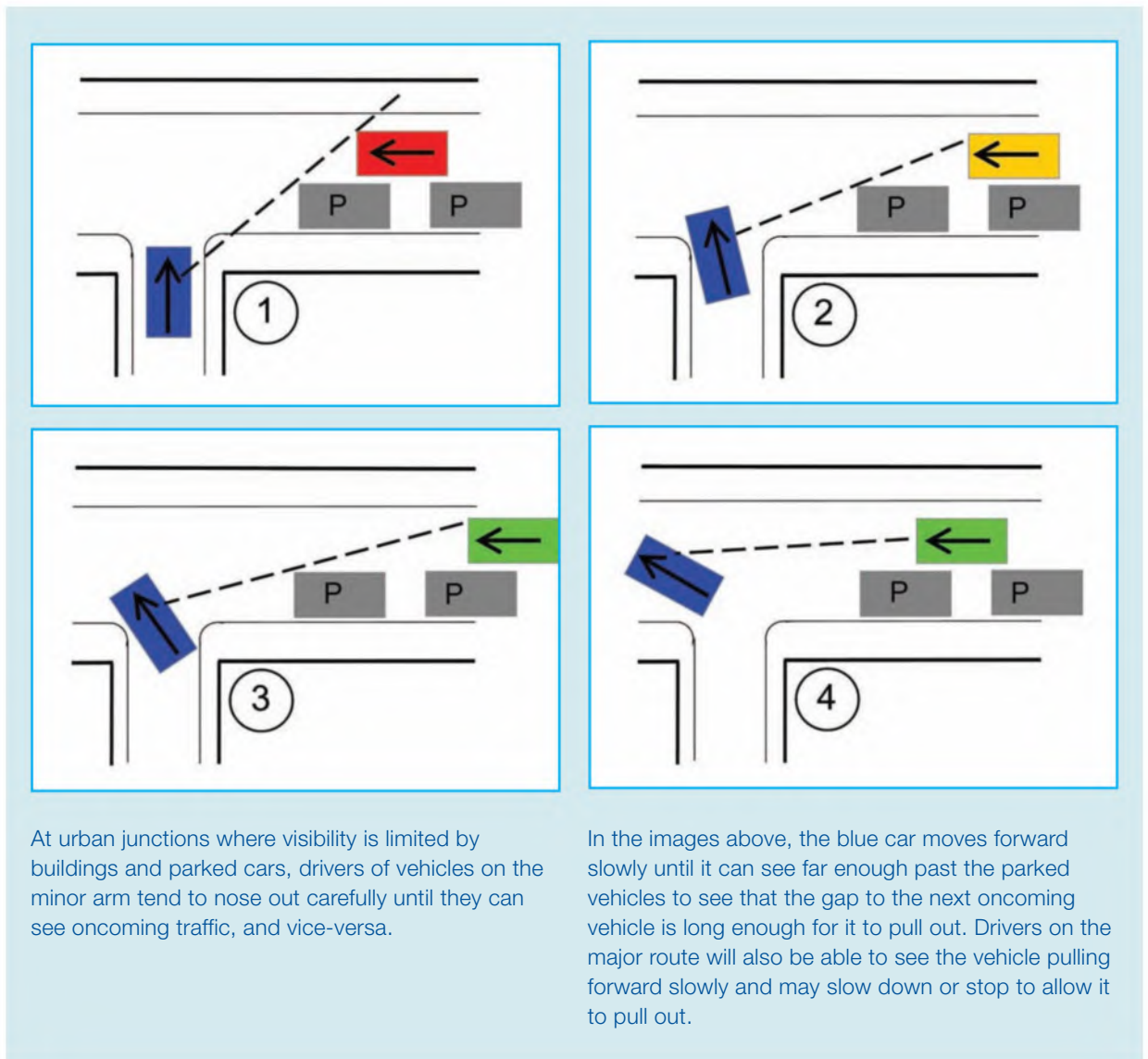

Figure 10.3

## 10.7\_ Obstacles To Visibility

**10.7.1** Parking in visibility splays in built-up areas is quite common, yet it does not appear to create significant problems in practice. Ideally, defined parking bays should be provided outside the visibility splay. However, in some circumstances, where speeds are low, some encroachment may be acceptable. (See Example below.)

**10.7.2** The impact of other obstacles, such as street trees and street lighting columns, should be assessed in terms of their impact on the overall envelope of visibility. In general, occasional obstacles to visibility that are not large enough to fully obscure a whole vehicle or a pedestrian, including a child or wheelchair user, will not have a significant impact on road safety.



At urban junctions where visibility is limited by buildings and parked cars, drivers of vehicles on the minor arm tend to nose out carefully until they can see oncoming traffic, and vice-versa.

In the images above, the blue car moves forward slowly until it can see far enough past the parked vehicles to see that the gap to the next oncoming vehicle is long enough for it to pull out. Drivers on the major route will also be able to see the vehicle pulling forward slowly and may slow down or stop to allow it to pull out.

# 11\_ On-Street Parking and Servicing

**11.1.1** Parking is an important consideration in the planning and design of highway networks, particularly in urban areas. General guidance on the development of parking strategies is given in the IHT publication 'Parking Strategies and Management' (2005)<sup>69</sup> and the document 'Car Parking, what works where'<sup>70</sup> provides a comprehensive analysis of the design of parking in residential and mixed-use areas.

**11.1.2** On-street car parking can be a vital component of highways, particularly where routes pass through town centres and commercial areas. The decision whether or not to provide on-street car parking should take into account its positive and negative effects, as summarised in MfS1:

## Positive Effects

- A common resource, catering for residents', visitors' and service vehicles in an efficient manner.
- Able to cater for peak demands from various users at different times of the day, for example people at work or residents.
- Adds activity to the street.
- Typically well overlooked, providing improved security.
- Popular and likely to be well-used.
- Can provide a useful buffer between pedestrians and traffic.

## Negative Effects

- If there are few places for pedestrians to cross with adequate visibility it can introduce a road safety problem, particularly if traffic speeds are above 20mph.
- Can be visually dominant within a street scene and can undermine the established character.
- May lead to footway parking, unless the street is properly designed to accommodate parked vehicles.
- Vehicles parked indiscriminately can block vehicular accesses to premises.
- Cars parked on-street can be more vulnerable to opportunistic crime than off-street spaces.
- Providing parking bays potentially reduces footway space, which could also be used for cycle parking.

**11.1.3** Where car parking is provided, a good solution is to break it into discrete groups of spaces with build outs that provide opportunities for pedestrians to cross with good visibility.



Well-integrated on-street parking.

**11.1.4** Car parking alongside carriageways can be longitudinal, echelon or at right angles to the kerb. Longitudinal parking will be more appropriate where traffic speeds and volumes are higher, since vehicles entering and exiting the spaces cause less interruption to traffic flow. In town centres and other locations where speeds are low, echelon and right angled parking may be the best solution, since it is more efficient and creates a stronger statement that the area is for 'place' activities as well as for movement.



Manchester Ancoats Before and After.

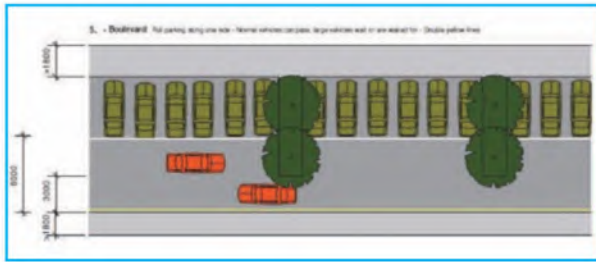

Manchester Ancoats Plan

**11.1.5** Echelon parking may be more difficult for pedestrians to pass through than longitudinal and right angled parking, depending on the spacing of parked vehicles, and can provide a greater barrier to crossing the street. This can be solved by leaving regular gaps between parked vehicles, however. It is easier for vehicles to enter and exit echelon than right angle spaces and so the former have less impact on through traffic.

**11.1.6** With echelon and right angle parking, care has to be taken that overhanging vehicles do not have an adverse impact on the available footway width. This can be addressed by providing generous footways, or using street furniture or wheel stops, in the form of dished channels, to prevent vehicles from encroaching too far.

**11.1.7** On-street servicing bays are often required in urban centres where commercial premises can only be accessed from the front. Where they are designed as lay-bys, they can be difficult to keep clear of parked cars and take space away from pedestrians that is empty for much of the time. Some authorities are placing loading areas on strengthened areas of the footway, which makes it much less likely that space will be used for parking, and allows pedestrians to use the space when there are no vehicles present.

**11.1.8** This approach has been used in numerous locations in London in recent years<sup>71</sup>.



On-footway servicing bay - Walworth Road MPR Scheme, London

**11.1.9** The minimum widths required to manoeuvre to/from 2.4m wide parking spaces are as follows:

- 90° - 6m
- 60° - 4.2m
- 45° - 3.6m
- 30° - 3.6m

**11.1.10** Where parking is provided on street, this manoeuvring width will generally be provided by the carriageway.

**11.1.11** For echelon and right angle parking, manoeuvring space can be reduced by providing wider spaces, as shown in Figure 8.20 of MfS1.

## 12\_ Street Furniture and Trees

### 12.1\_ Introduction

**12.1.1** Street furniture is the collective term for the wide range of extraneous items that are placed in highways, most of which is to be found outside the carriageway. Street furniture has an important role to play in facilitating the use of the highway for many purposes, and some items support important 'place' functions, such as seating and cycle parking. While trees may not be strictly classed as street furniture, they are important elements within highways that are highly beneficial, although they should be located and managed carefully.

**12.1.2** In recent years there has been increasing concern that excessive and poorly-planned and maintained street furniture is seriously degrading the quality of the local environment.

**12.1.3** Based on the guidance that is already contained in MfS1 the key principles that should be followed with respect to street furniture, including traffic signs, are as follows:

- Designers should start from a position of having no street furniture and only introduce these elements when they serve a clear function.
- Street designs should be as self-explanatory as possible, so that the number of signs can be minimised. Providing additional signs may not solve a particular problem - it may be necessary to consider removing signs and dealing with the problem another way.
- Excessive street furniture should be avoided, although street furniture that is of direct benefit to street users, such as seating and cycle parking, can contribute to a sense of place, making the street a destination in its own right.
- Street furniture should be laid out so that pedestrian routes along and across the street are kept clear.
- New street furniture should be well designed and in sympathy with the character of the street. Items of historic interest should be retained.

**12.1.4** Further detailed advice on minimising the number and impact of traffic signs is given in **Chapter 13**.



Excessive signs and street furniture can have a severe impact on the public realm.

**12.1.5** A proliferation of street furniture can often arise in mixed-use environments. This is made worse when complex traffic management systems are also used. Consequently the key principles from MfS1 are even more important to consider in the context of the wider range of street and road types that are covered by this document.

**12.1.6** Local Transport Note 1/08 'Traffic Management and Streetscape'<sup>24</sup> provides advice on how to manage street furniture in a more sensitive way, with particular emphasis on the processes that should be followed. Whilst LTN 1/08 focuses on traffic management schemes, its principles can be applied more generally, including on new and improved highway schemes.

**12.1.7** Reducing the amount of street furniture will bring significant benefits in terms of visual amenity. It is only possible to appreciate the character of an area if it is not obscured by excessive standardised street paraphernalia.



Character Obscured



Character Revealed - same location, same street furniture, but rationalised (Images Courtesy Colin Davis)



**12.1.8** Other benefits of reducing the amount of street furniture include:

- reducing the costs of provision and maintenance.
- improving the overall image of a place, helping it to function well economically and making its features of interest, such as heritage buildings and structures, stand out more clearly.
- improving the safety and amenity of pedestrians, particularly people with impaired mobility and people who are blind or partially sighted.
- making those signs that are most important stand out more clearly, improving safety and user behaviour.

In summary, less can be more.

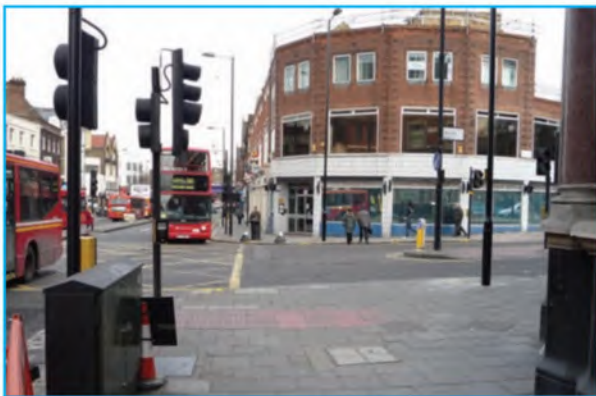

Mare Street Hackney - Before and after a decluttering scheme in August 2007. Casualty records have revealed a safety neutral outcome.

## 12.2\_ Procedures For Reducing Street Furniture

**12.2.1** In existing streets, highway authorities, working closely with other agencies and other interested parties, can carry out targeted decluttering schemes, reviewing traffic signs and street furniture. This will identify what can be removed without adversely affecting road safety and the proper functioning of the street. Highway authorities should also work with external bodies, such as the statutory undertakers, and with other local authority departments to prevent streets becoming degraded with excessive street furniture over time.

**12.2.2** It is also recommended that highway authorities adopt a process of decluttering as an integral part of their ongoing maintenance regimes. It will often be possible to identify items of street furniture that are redundant during routine street inspections so that they can be removed at little cost during maintenance operations. This process is covered by the 'tidy up' step in the London Mayor's Better Streets strategy<sup>25</sup>, set out in **Chapter 4**.



This guardrail has no function - the pedestrian route it was protecting has been closed - and can therefore be removed.

**12.2.3** When new highways are built or improvements are carried out, designers may over-provide and over-specify traffic signs, markings and other street furniture, based on the principle that they will only have one opportunity to provide such items. This practice adds unnecessarily to street clutter and should be avoided. Instead, the starting point should be that they are not to be provided unless there is a clear need for them. Where there is doubt over the need for any items, they should be omitted, and the situation monitored closely to establish whether they are justified in the light of experience.



Junction of Corporation Street and Croft Road, Coventry - Junction simplified, traffic signs, bus lane, keep left bollards and guardrail removed, cycle parking on median.

**12.2.4** Local policy and guidance on streetscape design and implementation processes has a key role to play in setting procedures for the progressive reduction of street clutter while promoting walking and cycling - see Example below.

**12.2.5** Local highway authorities are encouraged to develop policy documents to ensure that similar principles are adopted as a matter of course when existing highways are maintained and improved, and when new ones are being designed.

Transport for London's 'Streetscape Guidance'<sup>72</sup> contains detailed advice on the use of appropriate materials and details across the TfL network, and requires designers to ensure that:

- Signs are sufficient to enforce the regulations but are not excessive in terms of numbers and size.
- Key views and landmark buildings are not obstructed by poorly located street furniture, unless there is an unavoidable safety or security need.
- Clear pedestrian routes are maintained by removing redundant furniture and locating new furniture outside pedestrian desire lines.
- Clutter is reduced by combining elements of street furniture, such as signals and signs on street lighting or CCTV columns, incorporating bins and seats into bus shelters, and by mounting street signs and equipment on buildings or structures, wherever it is safe and acceptable to do so and the agreement of the owner has been obtained.
- The extent and visual impact of safety fences and barriers is reduced to the minimum required for safety and security to lessen visual impact and severance effects.

## 12.3\_ Keeping Footways Clear

**12.3.1** Guidance on the space requirements for pedestrians is contained in Section 6.3 of MfS1 and can be related to the volume of pedestrians per square metre (Fruin Level of Service). Experience from Copenhagen<sup>73</sup> indicates that pedestrians start to take alternative routes when the flow exceeds 13 people per metre of footway width per minute.

**12.3.2** In many places, however, particularly in town centres, the effective width of footway is significantly reduced by the presence of street furniture and other obstacles (see box out on UCL research). Waste bins are a particular hazard in many cities. ADEPT have published their practical guide for developers and local authorities called 'Making Space for Waste'<sup>74</sup>.

### The Influence of Street Furniture on Pedestrian Footway Capacity

Research carried out at UCL by Peter Jones and Rachel Palfreeman<sup>75</sup> looked at the space requirements of different types of street furniture located on the footway. The amount of space taken up by such objects is often much greater than their



Street furniture and other clutter affecting footway capacity

But there is a second factor which further reduces pedestrian capacity, which has not previously been taken into account. This is the 'footprint in use' of the object. This may result either from the intended use of an object (e.g. additional space taken up by a cycle parked against a cycle rack; a person sitting on a bench with shopping bags or a pushchair alongside; or people queuing to use a cash

physical footprint due to two factors. First each object has a 'no go' buffer space around it as pedestrians seek to avoid coming into contact with the object. The literature has historically assumed a 0.3 to 0.45m buffer width, but this research suggests that it varies according to pedestrian flow rates and can be as little as 0.1m at high rates of flow – see figure below.

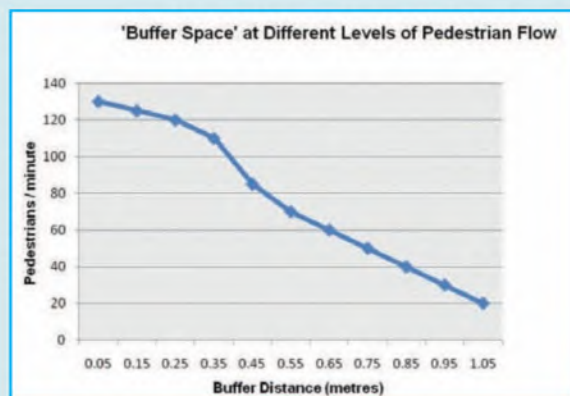

machine), or from unintended use (e.g. rubbish bags left next to a bin, or cycles parked alongside pedestrian guardrailing). The 'footprint in use' may add considerably to the physical footprint of the object itself, as shown in the table below, and so have a major impact on pedestrian flows and the use of the footway.

Item of Street Furniture	Typical Dimensions	Extra footprint (footway width occupied) when in use
Bus Shelter	0.28m x 3.9m to 1.3m x 5.2m	0.4m to 1.1m
Cycle Stands	0.1m x 0.6m to 0.1m x 0.7m	0.5m
Litter Bins	0.5m x 0.5m to 0.6m x 0.6m	0.1m to 0.9m
Cash Machines	NA	0.55m to 1.6m

**12.3.3** The first step to improve conditions for pedestrians is to remove any unnecessary obstacles, whether through regular maintenance processes, a decluttering programme or through the prevention of ad-hoc installation of features by external agencies such as utilities, by developing local working and communication arrangements. Encroachment by frontagers, such as by A-boards or licensed street trading, should also be controlled.

**12.3.4** Where substantial items of street furniture, such as street lighting columns, are to be replaced the opportunity should be taken to co-locate items onto a single pole wherever possible, with individual departments of a local authority and external agencies working together. Items such as traffic signal heads, belisha beacons and litter bins can all be dealt with in this way. Street elements can also be mounted on walls and other structures to remove the need for a pole entirely.



Maid Marian Way, Nottingham

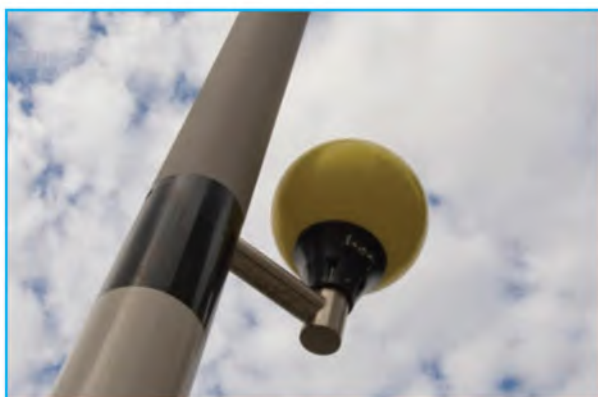

Belisha Lamp Column

**12.3.5** Street furniture should be located in a consistent place so that a clear pedestrian zone is maintained. Normally street furniture will be positioned between pedestrians and the carriageway to avoid affecting access to buildings and to provide a buffer to passing traffic.



Source - TfL 'Streetscape Guidance'<sup>72</sup>. Note - 'Inclusive Mobility'<sup>35</sup> advises that minimum width for pedestrians of 1m should only be used for distances of up to 6m.

**12.3.6** Bollards create an obstacle to pedestrian movement and can also be visually intrusive, particularly when used in large numbers. They are often installed where there is a concern that vehicles will encroach onto pedestrian areas, particularly in level surface schemes, but they have tended to be over-used as they provide an 'easy' design solution.

**12.3.7** Where designers consider it essential to prevent vehicles gaining access to a footway or pedestrian area, items of street furniture with a definite purpose, such as seating, cycle racks or trees, will often be preferable. Better enforcement of parking can also have a part to play.



Bollards can add considerably to street clutter.

**12.3.8** When used, bollards should be of a minimum height of 1m so that they are detectable by visually-impaired people.

## 12.4\_ Guardrail

**12.4.1** Guardrail is usually installed where there is a risk, or perceived risk, that pedestrians and/or cyclists will, in its absence, cross carriageways away from designated crossing points, or will otherwise wander into places where they can come into conflict with motor traffic. It is widely used in the UK, both on existing streets where a problem has been identified, and often on new or improved highway schemes as a matter of course.

**12.4.2** Guardrail is a very intrusive element. It disadvantages pedestrian movement by making people walk further, away from their desire lines, and creates an unpleasant feeling of restraint. It also narrows the usable footway which can lead to congestion. It is unsightly and detracts from local character and visual amenity, and there is evidence that it can increase traffic speeds and present an increased risk to cyclists, who can be crushed against it by vehicles.



**12.4.4** Local Transport Note 2/09, 'Pedestrian Guardrailing'<sup>176</sup>, provides advice with respect to guardrailing, including:

- a description of the development of policy guidance on guardrailing;
- an assessment procedure for the evaluation of the need for the installation or removal of guardrailing; and
- encouragement for authorities to consider developing and using an audit trail, recording decisions and actions when considering guardrailing.

**12.4.5** LTN 2/09 advises that alternative measures should be considered before a decision is taken to install guardrailing. Such measures may include:

- Reducing traffic speed;
- Relocating or installing a new pedestrian crossing to better fit pedestrian desire lines;
- Footway improvements and widening;
- Providing straight-ahead pedestrian crossings; and
- Using other means of directing pedestrians if this is necessary.

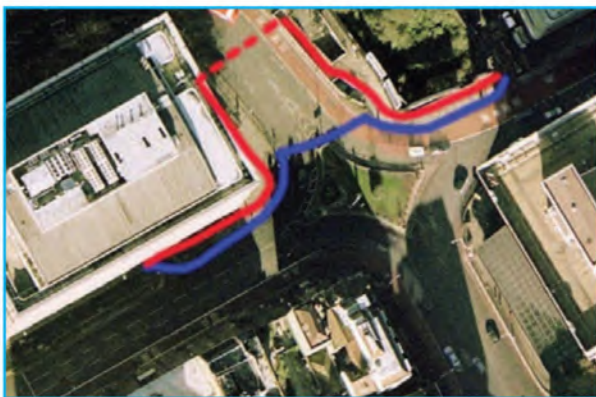

Despite extensive guardrailing, many pedestrians still choose to take the shortest path, putting themselves at greater risk. The red line shows the designated path, the blue line where many people walk.



Guardrailing can add to pedestrian congestion

**12.4.3** There is a pressing need to strike a more appropriate balance in the use of guardrail. That is not to say that there are no locations where it may be necessary - but it should only be used when no other solution to a significant safety problem is practically possible, and the adverse effects on amenity, capacity and safety have been fully evaluated and recognised.

**12.4.6** Experience has shown that the careful removal of guardrail from existing streets does not necessarily result in a worsening of road safety (see Prince of Wales Road Example below).

Prior to its improvement, as part of the DfT's Mixed Priority Route demonstration project Prince of Wales Road in Norwich had a very poor collision record and a poor quality environment.

As part of the scheme, guardrails were removed from most of the street, footways were widened, all on-street parking moved into defined bays, and the public realm was improved (including the rationalisation and reduction of street furniture and the introduction of street trees).



Before and after pictures of Prince of Wales Road and Upper King Street, Norwich

At some junctions, kerbs have been used successfully to define staggered crossings rather than using guardrail. These give guidance to less confident pedestrians (including visually impaired people) on the direction of stagger, whilst allowing more confident pedestrians to cross on their direct desire lines.



Pedestrians choosing different routes to cross the carriageway

Prior to the scheme being implemented the street had a very poor casualty record of 23 per year (44 per km), 75% of whom were pedestrians and cyclists. In the three years after implementation, the average number of casualties had reduced by 60% despite an increase of 16% in pedestrian footfall.

**12.4.7** Guardrail has been extensively used in the past as a means of preventing footway parking, and of discouraging parking generally. This is not an appropriate use of guardrail - better enforcement should be used instead. If it is necessary to control vehicle access to an area, other useful street furniture such as a bench could be used. Where footway overrunning is a problem it may be simpler just to increase the construction depth so that overrunning can be tolerated.

**12.4.8** Guardrail is commonly installed when pedestrian and cycle routes meet a carriageway. There should be no presumption that this is necessary, unless there is a reason to think that pedestrians are more at risk than when approaching a junction along a footway next to a carriageway - a situation where guardrail is not provided by default.

**12.4.9** Guardrail is often installed as a matter of course at new junctions, even when there is no particular reason to think that pedestrians are at a high risk of injury. As with other street elements, highway authorities should start with the presumption that no guardrail is necessary. If it is considered that it may be needed, only the minimum amount should be installed, after considering all other ways of resolving the issue. If in doubt, it may be better to omit the guardrail and carefully monitor the site after the scheme opens to establish whether it is needed in the light of actual usage.



Newly-implemented highway scheme with extensive guardrailing

## Guardrail assessment procedures

**12.4.10** When considering the removal of guardrail, authorities should go through a well-documented process to show that the decision has been made following careful consideration of all relevant factors. General advice on managing authorities' liability is given in **Chapter 3**.

**12.4.11** LTN 2/09<sup>76</sup> provides an assessment tool for authorities considering the removal of guardrail from existing junctions, based on research carried out by the University of Southampton (see box out). The method uses the evidenced comparison of sites with and without guardrail, and does depend on data from a similar comparison site being available. It focuses on the degree of compliance with crossing points rather than a road safety assessment.

### Guardrail research

Research on the effectiveness of guardrail has been carried out by University of Southampton for the Department for Transport. The research for DfT, which underpins LTN 2/09<sup>76</sup>, examined 78 junction and crossing sites with and without guardrailing in the UK outside London and found that:

- The frequency of all collisions and pedestrian collisions was some 1.5 to 1.6 times higher at sites with guardrailing than sites without guardrailing, (although this may in part be due to the with-guardrail sites having slightly higher traffic flows and speeds).
- Guardrailing does (unsurprisingly) increase the proportion of pedestrians that cross in the designated places.
- However, there is no conclusive evidence that the inclusion of pedestrian guardrailing at any type of pedestrian crossing or junction has any statistically significant effect on road safety.

**12.4.12** Transport for London has developed a Guardrail Risk Assessment Form<sup>77</sup> which provides a method for the assessment of the suitability of pedestrian guardrail at an existing site.

**12.4.13** A more context-sensitive methodology for the assessment of the need or otherwise for guardrailing has been developed by Urban Initiatives for LB Hackney<sup>78</sup>. Details of the procedure are given in the box out below.

**12.4.14** Local highway authorities are advised to develop similar tools, which can also consider how measures described in 12.4.5 above, together with more general public realm improvements, can reduce or eliminate the need for guardrail.

### LB Hackney – Guardrail Assessment Procedure

The methodology consists of two parts:

Part A provides a framework for the determination of the necessity for guardrail, up to the stage at which revised design proposals, if necessary, are brought forward. These proposals should be audited in an independent safety audit.

Part B considers the recommendations of the safety audit, and, where problems are identified with the scheme developed in Part A, weighs up all the information considered in the previous stages, and records the authority's conclusion.

#### Part A

Stage 1a of the procedure considers the character of the place, how different users perceive it and how the current design favours one or more groups. Stage 1b then considers road safety issues specifically, including the collision record, vehicle speeds and the presence of any vulnerable users.

Stage 2 assigns the location to one of 12 street types, ranging from a pedestrianised street to a major distributor road in a non-built up area.

Stage 3 assesses the in-principle appropriateness of guardrail, depending on the street type. For example, guardrail is considered to be never appropriate in a pedestrianised street, sometimes appropriate in high streets and likely to be necessary on major distributor roads.

Stage 4 then identifies desire lines on the assumption that there is no guardrail considering local origins and destinations such as doors in nearby buildings. The assessor then identifies where these important pedestrian movements coincide with major vehicle movements. Guardrail may be needed to influence these conflict points but should not otherwise be considered in most situations.

Stage 5 assesses the severity of these conflicts at coincidence points and other locations, and whether there are any particular concerns.

Stage 6 then considers whether guardrail is an appropriate means of diminishing danger at these conflict points, or whether there are any other/better tools that could be used, even if these cannot be delivered in the short term. From this assessment, proposals for the installation or retention of guardrail, or other measures, are developed.

#### Part B

The recommendations from Part A may then be subject to a Road Safety Audit. If this does not identify problems with the proposals, the process is complete.

If problems are raised by the Safety Audit, a documented process considers the previous proposals and the Audit recommendations, leading to an exception report and a final decision.

## 12.5\_ Street Trees and Planting

**12.5.1** Trees bring a wide range of benefits both to individual people and to society as a whole. They contribute to character and distinctiveness, create visual interest and help to soften the urban environment. However, their potential contribution goes far beyond the purely visual; they have a critical role to play in helping to adapt urban areas to climate change, for instance, by providing shade and reducing the local environmental temperature<sup>79</sup> or by slowing the rate at which rainfall enters the drainage system.

**12.5.2** The introduction of trees as part of a scheme or improvements around existing trees is as much a specialist discipline as highway engineering and designers need to take advice from a qualified and professional arboricultural consultant or tree officer from the planning or highway authority at the planning stage of a scheme to ensure that suitable trees are used and their needs in terms of growth, protection and maintenance are appropriately catered for.

**12.5.3** Although providing and maintaining street trees have financial implications, the economic, environmental and social benefits vastly outweigh these costs. For example, a recent cost:benefit analysis study of New York street trees has revealed significant cost benefits<sup>80</sup>. Guidance on the asset valuation of trees (for non-timber purposes) has recently been published by the RICS<sup>81</sup>.



The street trees in the centre of The Circus in Bath are an example of how trees can contribute significantly to the quality of place.



**12.5.4** Recent studies have shown that in urban areas all over England trees are under threat<sup>82</sup>. Large, mature trees are under particular threat, while new trees being planted tend to be smaller varieties. It is worth noting that the benefits that trees bring are proportionate to their size: large, mature trees bring more benefits than small ones. The potential contribution of trees will be further improved where they are integrated into 'green infrastructure' networks.

**12.5.5** Large species will grow to have large canopies and extensive root networks. Designers should choose appropriate species and ensure that their physiological needs are incorporated into scheme designs. Information about the types of trees that will survive in urban areas in England can be found at <http://www.right-trees.org.uk>.



Designers need to plan now to achieve streets lined with large canopy trees which will be vital in reducing the expected increase in urban temperatures anticipated with climate change. Appreciation of long-term growth issues such as root ball size and overhang of carriageway must be taken into account.

**12.5.6** Designers should take steps to prevent conflicts between tree root systems, underground services and building foundations<sup>83</sup>. Wherever possible underground services should be routed in shared service ducts. Ducts make maintenance easier and minimize the amount of space taken by services. Modern utilities in plastic ducting can tolerate deformation by tree roots in ways that older services cannot.

**12.5.7** Tree pits are an important part of tree planting proposals in an urban street environment and the design will be site specific due to the nature and conditions of the local environment. An arboricultural consultant or tree officer must be consulted to provide advice on tree pit design to ensure trees can grow to maturity.

**12.5.8** One of the underlying reasons why urban trees are under threat is that many people believe they cause a range of problems. This section considers whether or not these perceptions are realistic, and outlines ways in which potential problems can be avoided.

**12.5.9** The incidence of subsidence in urban areas that is caused by trees is far lower than assumed. One study in a London borough found that only 0.05% of its building stock was affected by tree-related insurance claims annually. Selecting appropriate species for a location and maintaining the tree appropriately will ensure that roots do not affect building stock. The London Tree Officers Association has produced 'A risk limitation strategy for tree root claims'<sup>84</sup>.

**12.5.10** Measures to be taken to avoid common problems include:

Pavement lift:

- Ensure that the planting pit is designed and built to allow for root expansion in the future.
- Where necessary, it might be possible to have non-structural surface roots removed.

Footpath obstruction

- Ensure pavements are sufficiently wide to accommodate large species trees where appropriate.
- Where trees have already grown too wide for a path, it might be possible to build the path out into the street so that pedestrians can go round the tree trunk.

Leaf litter and fruit fall

- Leaf litter and fruit fall can be collected by local authorities and used to create locally sourced compost.
- Blocked gutters and drains can be avoided by fitting mesh guards.

- 12.5.11** For further guidance, see:
- Trees and Design Action Group <http://www.tdeg.org.uk>
  - CABE 'Managing Urban Trees'<sup>195</sup>
  - Trees for Cities <http://www.treesforcities.org.uk> and guidelines on street trees<sup>96</sup>
  - Mayor of London's Street Trees <http://www.london.gov.uk/streettrees/>
  - Greater London Authority 'Right Trees for a Changing Climate' <http://www.righttrees.org.uk>
  - Communities and Local Government trees web pages <http://webarchive.nationalarchives.gov.uk/+/http://www.communities.gov.uk/planningandbuilding/planning/trees/highhedges/trees/>
  - Chris Brit and Mark Johnston, 2008 'Trees in towns II: a new survey of urban trees in England and their condition and management'<sup>82</sup>
  - Communities and Local Government, 2006 'Tree Roots in the Built Environment'<sup>87</sup>

## 12.6\_ Street Lighting

12.6.1 Street lighting can contribute to:

- improving road safety;
- assisting in the protection of property;
- discouraging crime and vandalism;
- making residents and street users feel secure;
- Enhancing the appearance of the area after dark; and
- Encouraging walking, cycling and the use of public transport.

**12.6.2** MfS1 provides advice on the design of street lighting. The following key principles are given, which can be applied to the range of highway types covered by MfS2.

- Lighting should be planned as an integral part of the street layout, including any planting. The potential for planting to shade out lighting through growth should be considered when deciding what to plant.
- Lighting should be appropriate to context and street function. In some locations, such as rural villages, lighting may not have been provided elsewhere in the settlement and therefore it may not be appropriate in new developments.
- Lighting should illuminate both the carriageway and footway.
- The height of street lighting units should be appropriate to the cross-section of the street. Lowering the height of lighting can make the scale more human but this will mean that more lighting units are required.
- Lighting levels do not have to be constant during the hours of darkness.
- Lighting columns should be placed so that they do not impinge on the available widths of footways.

- Lighting design should ensure that shadows are avoided in streets where pedestrians may be vulnerable. Sudden changes in lighting level can be particularly problematic for partially sighted people.
- It is important that lighting is carefully designed to reduce stray light.
- Consideration should be given to attaching lighting units to buildings to reduce street clutter.



Inconspicuous lighting units on buildings help to minimise clutter in this village high street.

**12.6.3** Sustainability is an important consideration. The Carbon Reduction Commitment Energy Efficiency Scheme (CRCEE) and the Energy Using Products Directive (EuP) should be taken into account in the design of lighting schemes. Other recent legislation that should be considered includes the Climate Change Act (2008) and the Energy Act 2008 (Consequential Amendments) Order (2009).

**12.6.4** Current guidance documents on street lighting include the following:

- BS 5489 (2003) Code of Practice for the Design of Road Lighting - Part 1: Lighting of Roads and Public Amenity Areas<sup>88</sup>.
- BS EN 13201-2: 2003 Road Lighting - Performance Requirements<sup>89</sup>.
- BS EN 13201-3: 2003 Road Lighting - Calculations of Performance<sup>90</sup>.
- BS EN 13201-4: 2003 Road Lighting - Methods of Measuring Lighting Performance<sup>91</sup>.
- \*Guide on the Limitation of the Effects of Obtrusive Light from Outdoor Lighting Installations<sup>92</sup>.
- 'Guidelines for Minimising Sky Glow'<sup>93</sup>.
- Institution of Lighting Engineers (ILE) (2005) 'Guidance Notes for the Reduction of Obtrusive Light'<sup>94</sup>.
- 'Lighting in the Countryside: Towards Good Practice'<sup>95</sup>.



Anti-ram walls that also provide seating outside the Supreme Court, Parliament Square

special materials and foundations and, in so doing, they are not frangible or likely to bend if accidentally hit.

## 12.7\_ Security Measures

**12.7.1** With an evolving criminal and terrorist threat to infrastructure and areas where high concentrations of the public may gather, certain sites may have anti-ram protection measures installed to protect them from vehicle-borne attack. Such countermeasures would typically consist of vehicle security barriers such as bollards, planters, structural walls or balustrades, appropriately resilient landscape architecture, or using structural elements concealed within common streetscape items such as shelters, benches, cabinetry, signposts and lighting columns.

**12.7.2** For protection reasons, their position is usually optimised as far from the vulnerable site as possible. The advantage of having an effectively managed cordon-based scheme, where barriers are located at the furthest perimeter of a vulnerable site, is that individual assets within the area will not typically need to be protected with extra security barriers, thus helping a local authority achieve its objectives with minimal clutter.

**12.7.3** If designed to be permeable by pedestrians then the spacing between structures will be no more than 1.2m apart such that hostile vehicles cannot encroach through the gaps. They are unlikely to be less than 1 metre apart so that people with impaired mobility are not inconvenienced. Although dressed to blend in to the architecture and streetscape in an urban area, these measures are designed to resist forced attack using

## 13\_ Traffic Signs and Markings

**12.7.4** In future years, town and city centres may install permanent retractable bollard and gate schemes not just for bus priority or environmental reasons but also to include a security theme and thus be specified to a security specification. These measures may be in place full time or just at times of increased risk (e.g. when the site is crowded or when a secure event is being hosted in town).

**12.7.5** Any traffic regulation introduced for this national security purpose will typically be accompanied by Anti-Terrorist Traffic Regulation Orders (ATTROs using Sections 22C or 22D of the Road Traffic Regulation Act 1984 as amended by the Civil Contingencies Act 2004).

**12.7.6** Further information is available in the Home Office's documents "Working Together to Protect Crowded Places"<sup>96</sup>, "Crowded Places: The Planning System and Counter Terrorism"<sup>97</sup> and "Protecting Crowded Places: Design and Technical Issues"<sup>98</sup>. Protective security advice and a palette of appropriately resilient vehicle security barriers or structural elements for embedding in the public realm are available from specialists at the UK Government's Centre for the Protection of National Infrastructure (CPNI) or via the local police Counter-Terrorism Security Adviser (CTSA).

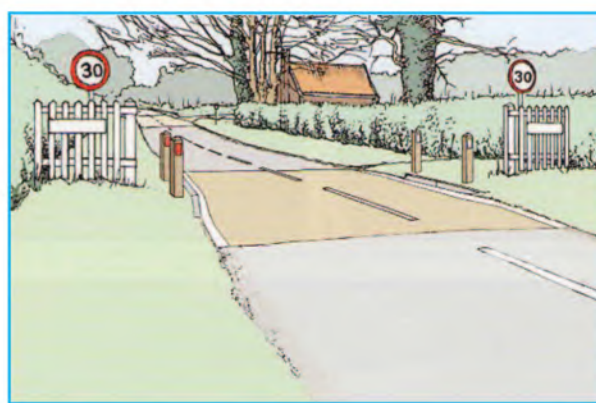
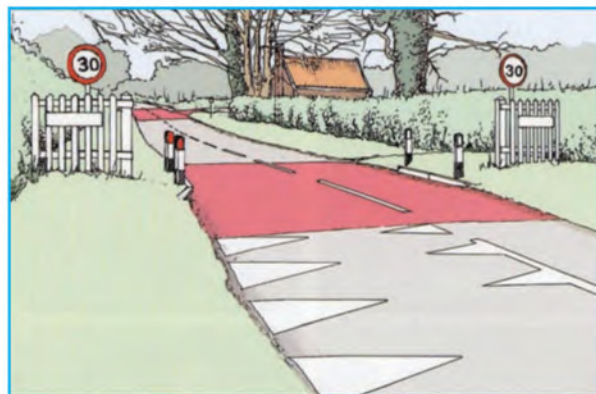

Village gateways do not have to use garish colours - images taken from the Suffolk Countryside Manual, produced by Suffolk County Council<sup>100</sup>.

### 13.1\_ Introduction

**13.1.1** Traffic signs and markings add significantly to the amount of street furniture and it is important that highway authorities look for opportunities to reduce excessive signing, where this would not have a detrimental impact on road safety. Examples of where this could be done, whilst complying with the legal requirements of the Traffic Signs Regulations and General Directions (TSRGD) and other Regulations, are given in this section of the document.

**13.1.2** Based on the guidance that is already contained in MfS1 the key principles that should be adopted with respect to traffic signs are as follows<sup>9</sup>:

- The Traffic Signs Manual (TSM)<sup>99</sup> and other DfT publications such as Traffic Advisory Leaflets provide advice to designers on signing.
- Whilst signs must comply with legislation in the form of the TSRGD<sup>58</sup> and the Crossing Regulations<sup>52</sup>, there is flexibility within the regulations.
- Highway Authorities should not see TSRGD and the TSM as constraining documents, and they are able to use the flexibility in the documents to suit local circumstances.
- TSRGD does not require any signs to be installed. However, signs are needed to warn, inform or to give effect to Traffic Regulation Orders.

**13.1.3** Chapter 3 of the Traffic Signs Manual notes that research has shown that the greater the number of signs

that drivers are presented with simultaneously, the greater the difficulty they are likely to have in assimilating all the information.

**13.1.4** Excessive signs and road markings can be particularly intrusive in rural areas, where it can have an urbanising influence. The impact is not only aesthetic; many rural economies are dependent on tourists, attracted by the quality of the landscape, which can be damaged by insensitive design. Some authorities, such as Dorset County Council, have developed policies for managing rural roads in a more sensitive way.

<sup>9</sup> Note – road 'markings' are legally 'signs' and so the latter includes the former

## 13.2\_ Size and Mounting Height Of Signs

**13.2.1** Advice on the size of signs is given in the various chapters of the Traffic Signs Manual<sup>99</sup> and is generally related to actual traffic speed (85th percentile values) and in some cases the speed limit.

**13.2.2** Although highway authorities should take account of this advice in determining the size of signs, it should be noted that it is not unlawful to deviate from the advice contained in these documents. TSRGD<sup>58</sup> sets out the



Sign mounted at low level

sizes of signs that can be used, and highway authorities are at liberty to select from these alternative dimensions.

**13.2.3** The Traffic Signs Manual confirms this, noting (in Chapter 3, Appendix A) that smaller signs may be used where special amenity considerations apply, but noting that this will offer drivers less time to react to the sign. Highway authorities will need to judge, based on the importance of the information on the sign and the consequences of drivers not being able to read it in time, whether this will lead to a significant road safety problem.

**13.2.4** There is no legal requirement for signs to be mounted at a particular height, although the Traffic Signs Manual recommends that signs are generally set with their lower edge between 0.9m and 1.5m above carriageway level, and 2.1 to 2.3m above footways and cycle tracks. While their effectiveness may be reduced, mounting signs at lower levels can reduce the visual impact of signs and may be appropriate in some situations, particularly rural



If all signs have yellow backing boards, how well does a particular sign stand out?

areas where it is often important to mount traffic signs below adjacent hedges or walls to minimise the impact on long views across the countryside.

## 13.3\_ Yellow Backing Boards

**13.3.1** Yellow backing boards are placed on signs to increase their conspicuity and while this may be appropriate in some exceptional circumstances, this technique significantly worsens their visual impact. The effect is particularly marked when a blanket decision is



Multiple yellow retroreflective bollards can have a significant visual impact.

<sup>c</sup> Note – retroreflective bollards complying with BS 8442:2006 section 14 incorporating traffic signs which are not lit require special authorisation from the Department for Transport since they do not comply with TSRGD.

taken by a highway authority to use yellow backing boards on all signs along a route.

**13.3.2** Chapters 3, 7 and 8 of the Traffic Signs Manual<sup>99</sup> provide advice on the use of backing boards and notes that there are potential disadvantages to their use:



Keep left bollard, with rear face uncoloured

- Yellow backing boards can be especially environmentally intrusive, and their over-use devalues their attention-attracting benefits.
- Even a grey board can deprive triangular and circular signs of a primary recognition aid, their distinctive silhouettes.



Pedestrian refuge without keep left bollards, Walworth Road Mixed Priority Route scheme

- The larger overall size of the assembly can sometimes obstruct sight lines.
- Where it is necessary to increase a sign's conspicuity, a less garish way of doing this may simply be to provide a standard sign of larger size. Not only will this be more noticeable than a smaller sign, but it will also improve legibility and hence reading distance, which a yellow backing board cannot.
- Yellow backing boards will not normally be necessary when signs indicate an increase in the speed limit.



Sign to diagram 610 mounted on hoop top frame.



Sign to diagram 610 mounted on post. Note - yellow backing is not compulsory.

- Where it seems that a sign is not being noticed by drivers, it should be checked to ensure that it is well sited, not obscured by vegetation or other obstructions and is of the appropriate size and in good condition. Only then should the use of a yellow backing board be considered.

## 13.4\_ Keep Left/Right Signs



The London Road, Southampton scheme omits central line markings for part of its length.

**13.4.1** Signs to Diagram 610 (keep left or right) or 611 (pass either side) are typically provided at the ends of central islands and refuges and at kerb build-outs to warn drivers of the obstacle in their path. They are often mounted within illuminated or reflectorised bollards, which over recent years have increasingly been of the passively safe type, usually with a yellow reflective finish<sup>c</sup>.

**13.4.2** These can be highly intrusive, particularly where a large number of such bollards are installed at a junction.

**13.4.3** Where the highway authority considers that retro-reflective bollards are essential, they should give consideration to specifying that the coloured material is only provided on the side of the bollard that faces the traffic flow, so that the overall intrusive effect is reduced.

**13.4.4** Highway authorities should consider whether signs and bollards are required at every central island or kerb build-out, particularly where the area is lit and other vertical features would alert drivers to the presence of the obstacle. The Crossings Regulations<sup>52</sup> make it clear that signs to diagrams 610 and 611 are optional.

**13.4.5** Similarly, there is no legal requirement for such bollards and signs on the median islands on the approaches to roundabouts.

**13.4.6** Where traffic signs are necessary, there is a range of mounting and lighting arrangements that can be used. The hoop type of sign mounting has been used in many schemes, for various types of sign, and can be lit from below when this is necessary. Signs to Diagrams 610 and 611 can also be mounted on lamp columns and other street furniture.



Excessive use of coloured surfacing can be visually intrusive

## 13.5\_ Centreline Markings

**13.5.1** MfS1 notes that the use of centre lines is not an absolute requirement and includes reference to the reductions in traffic speed that result by omitting centreline markings on carriageways. This has been done successfully on busy routes in urban areas as well as in village settings. Removing centrelines can be done easily when carriageways are resurfaced, with an immediate saving in capital and ongoing maintenance costs.

## 13.6\_ Zig-Zag Markings

**13.6.1** Zig-zag markings on the approaches to pedestrian and cycle crossings are required under the Crossing Regulations<sup>52</sup>, which state that the number of zig-zag marks shall be between 8 and 18 in number. However, the regulations also state that the number of zig-zag



This junction has the Give Way marking (1003) and the approach triangle (1023) but no Give Way sign. It would have been possible to omit the approach triangle. Note also table to slow speeds and make pedestrian crossing easier.

marks may be reduced to 2, of a minimum length 1m, where the traffic authority is satisfied that, by reason of the layout or character of the location, it will be impracticable to comply with the normal requirements.

## 13.7\_ Coloured Surfacing



Roundabout in Taunton town centre with proceed left signs to Diagram 606 but no black and white chevrons to diagram 515. Note - cobbled surface is difficult for cyclists.

**13.7.1** Coloured road surfacing is often used to give greater conspicuity to areas that are hatched (to Diagrams 1040, 1040.2, 1040.3 and 1040.4) as being areas that should not be entered by vehicles unless it is considered by the driver to be safe to do so. It is also often applied to



One sign (Diagram 616), as shown on the lower image, can be legal and sufficient.

bus and cycle lanes in an effort to improve compliance. Anti-skid surfacing is also sometimes coloured, although less intrusive grey and buff colours are available.

**13.7.2** Coloured road surfacing has no legal significance. It adds to visual intrusion and should not be used by



Visually intrusive yellow lines in a narrow street.

default. It should be reserved for situations where it is considered that it will have a particular safety benefit, and where this outweighs the aesthetic disadvantages. Studies have shown<sup>101</sup> that coloured surfacing can reduce the number of vehicles overrunning hatched areas, but that the effect reduces with time as the colour fades. Coloured surfacing therefore creates an ongoing maintenance liability.

## 13.8\_ Signs and Markings at Junctions

**13.8.1** There is no legal requirement to use road markings to define priority at T-junctions or crossroads.

**13.8.2** The give way rule at T-junctions is often signed using both road markings to Diagram 1003 (give way line) and 1023 (approach triangle) and a sign to Diagram 602 (Give Way). However, not all are mandatory and highway authorities should consider whether it is necessary to go beyond the minimum legal requirement. The following options are possible:

- Give Way marking (1003) alone
- Give Way marking (1003) and approach triangle (1023)
- Give Way marking (1003) and approach triangle (1023) and Give Way sign (602)

**13.8.3** Roundabout central islands are usually signed with the proceed left arrow sign (Diagram 606) and black and white chevrons (Diagram 515) but it is lawful to omit both types of sign, or to use Diagram 606 without Diagram



515. At roundabouts and bends consideration could be given to reducing the size of signs.

**13.8.4** No entry signs (Diagram 616) are normally provided on either side of the entrance to a one-way street from a junction, but this is not a requirement of TSRGD where the carriageway or vehicle track width is less than 5m.

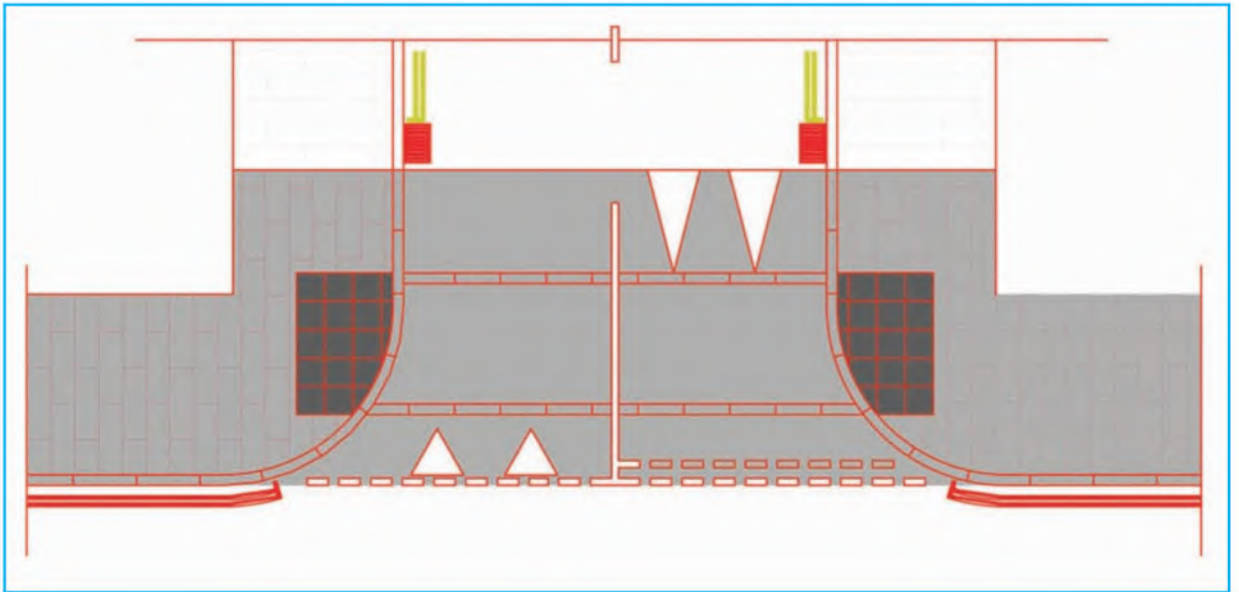

Detail for tabled side road crossing, omitting yellow/red markings across table

# Section C

## Case Studies

The detailed case studies have been developed on behalf of CAFE by John Dales and David Johns at Urban Initiatives. We are grateful to the project contacts for the time they took introducing us to their schemes. Visit the CAFE website ([www.cafe.org.uk](http://www.cafe.org.uk)) for detailed scheme drawings, a wider selection of street focussed case studies, and information about training and direct project support that we offer.

### Case Study Photograph Credits

The CIHT would like to acknowledge and thank all those who supplied photographs of the case studies they are listed below:

CS1 Ian Hingley Urban Initiatives

CS2 Louise Duggan

CS3 CAFE/Jane Sebire

CS4 CAFE/Jane Sebire

CS5 CAFE/Jane Sebire

CS6 CAFE/Jane Sebire

CS7 CAFE/Jane Sebire

CS8 CAFE/Jane Sebire

CS9 CAFE/Jane Sebire

CS10 Sam Wright TfL

CS11 CAFE/Jane Sebire

CS12 Southampton City Council

CS13 Graham Redman/Southampton City Council

CS14 Southampton City Council

CS15 Graham Redman Southampton City Council

CS16 Graham Redman Southampton City Council

CS17 Graham Redman Southampton City Council

CS18 Graham Redman Southampton City Council

CS19 Graham Redman Southampton City Council

CS20 Sheffield City Council

CS21 Sheffield City Council

CS22 Sheffield City Council

CS23 CAFE/David Millington

CS24 CAFE/David Millington

CS25 Urban Initiatives

CS26 Sheffield City Council

CS27 Sheffield City Council

CS28 CAFE/David Millington

CS30 CAFE/ David Millington

CS31 John Dales Urban Initiatives

CS32 CAFE/David Millington

CS33 David Johns Urban Initiatives

CS34 CAFE/James Whitaker

CS35 John Dales Urban Initiatives

CS36 Gillespies

CS37 CAFE/James Whitaker

CS38 CAFE/James Whitaker

CS39 Gillespies

CS40 Gillespies

CS41 Nottingham City Council

CS42 Nottingham City Council

CS43 Nottingham City Council

CS44 Nottingham City Council

CS45 CAFE/Stephen McLaren

CS46 CAFE/Stephen McLaren

## 14\_ Case Studies

### 14.1\_ Walworth Road, Southwark, London

#### Summary

Walworth Road in Southwark faced problems with road safety. As a distributor route with heavy traffic and a local high street with lots of shoppers things had become unbalanced:

- The street space was largely allocated to motor vehicles, including designated bus lanes.
- The footways were relatively narrow, and long stretches of guard rails stopped pedestrian movement both along and across the street.
- The guard railing also made servicing difficult for the many retail and other commercial properties which fronted the street.

Despite many conventional traffic engineering and road safety measures, the collision record gave considerable cause for concern.

Walworth Road became one of ten Department for Transport 'mixed priority route' demonstration projects. It was the most complex, because of its heavy traffic, and the high importance of making it a much more attractive place for shopping, business and the local community.



Photo CS1

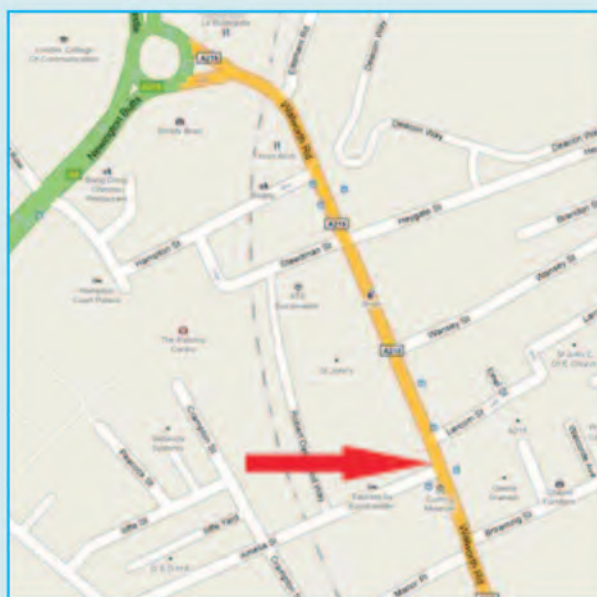

Photo CS2

The scheme helped to re-establish balanced provision changing from a traffic-dominated thoroughfare into a vibrant place for people –that still carries important traffic flows (see photo CS1 before and photo CS2 after).

#### Description

The A215 Walworth Road runs from the Elephant and Castle in the north to Albany Road in the south - some 1.2km. It is a key radial route, carrying around 20,000 vehicles per day. However, it is also an important and busy neighbourhood retail centre, in the area around the East Street Market (see photo CS3). Around 500m of the street in the heart of this centre was redesigned (see Location Plan).



Location Plan



Photo CS3

- the carriageway contained a dedicated bus lane and a general traffic lane in each direction
- vehicles and pedestrians were segregated by long sections of guard rails
- there were infrequent crossing facilities
- it was badly cluttered in places by typical permanent traffic management equipment and street furniture, and by temporary 'A-boards' placed there by local businesses.

One of the most critical issues was the reallocation of space (see photo CS5) – carriageway to footway – to enable the street to function far better as a local high street and neighbourhood centre. This was a very challenging task, given the fixed frontage to frontage widths and localised narrowness on the road in certain sections.

Generally the street is fronted by retail and commercial properties, though the immediate hinterland to both sides is residential. Walworth Road is mainly used by local residents from the nearby social housing. The lower levels of car ownership in the social housing sector mean it's all the more important to enhance the walkability of the local high street (see photo CS4). It's historic alignment and buildings create a well-defined street scale, but its relative narrowness was a problem for the modern-day demands of vehicles and pedestrians.



Photo CS4

### Balanced provision

Before the improvement scheme, Walworth Road was dominated by through vehicles. This came at the expense of pedestrian movement, and undermined the sense of place:



Photo CS5

### Public transport

A comprehensive transport assessment was done to find out the feasibility of removing bus lanes and redistributing some of this space to the footways. Ten different bus routes – with some 150 buses per hour at peak times – use the road.

Bus 'gates' were installed at both entrances to the scheme area (see photo CS6). These allow buses to have priority over general traffic. Nearly two years after the scheme opened, anecdotal evidence suggests that it has had little impact (either way) on bus journey times. Bus drivers often do not use the gates, even at peak times.



Photo CS6

Other critical elements of the scheme included:

- improved and new formal (see photo CS7) and informal crossing points along the street, including a wide median strip in the southern section of the scheme (see photo CS8)
- extensive tree planting (see photo CS9)
- seating (see Photo CS5)
- improved management of parking and loading (see photo CS10)
- improved pedestrian and vehicular lighting, through multi-function poles
- major de-cluttering - approximately 600 unnecessary signs and poles, and around 425m of pedestrian guard rails were removed.



Photo CS7



Photo CS8



Photo CS9



Photo CS10

## Design Process

### Scheme genesis

The scheme began life as a road safety scheme. A bid was made by the London Borough of Southwark for Department for Transport 'mixed priority route' road safety demonstration project funding. The bid's success encouraged the council not only to seek out innovative approaches to achieving better safety, but also to take a wider view of the street in the context of regeneration benefits.

### Procurement

Southwark Council commissioned a comprehensive transport and public realm design for the street, through a combination of conventional tendering and public competition. Five consultancies were initially asked to submit full tenders. From these, two were shortlisted to produce design concepts for the competition.

A public vote identified Project Centre as the winning designer, on the basis of:

- the scheme's simplicity
- the use of public realm elements appropriate for Walworth Road's use and character
- views on robustness and long-term cost-effectiveness.

### Disciplines/people involved

There were two principal workstreams – transport/safety and public realm/street design – and these ran largely in parallel. Officers from both Southwark Council and Transport for London (TfL) were closely involved, as well as the consultancy team.

A comprehensive traffic analysis and modelling exercise was carried out by Southwark and presented to TfL as part of the justification of the scheme. This information was used not only to determine the impact of the scheme on traffic flows – especially buses – but also to help identify opportunities for reallocating carriageway space to footways.

There was considerable public involvement throughout the design and delivery process, not only at the procurement stage. This included public meetings, targeted stakeholder events and a business questionnaire.

There was direct engagement with transport user groups, including:

- TfL (buses, signals, cycling and walking)
- the emergency services
- Southwark Cyclists

## Notable issues

Public consultation and engagement was a critical factor in the success of the project. Consultation with traders led to agreement on a reorganisation of loading and delivery arrangements. The primary changes were an increase in permitted loading times and relocation from carriageway to footway loading. A construction method was also developed in partnership with retailers to ensure continuous footway access to all premises during the build period. This was done through night working and careful phasing.

Given the many and complex transport issues along the street and negotiations with London Buses and TfL's Network Assurance team, it took over two years for the scheme design to be agreed.

## Technical Data

<b>Dates</b>	Contract mobilisation October 2006. Works largely complete in January 2008 with some minor amendments and snagging works continuing until March 2008.
<b>Volumes</b>	<ul style="list-style-type: none"><li>● Pre-scheme: 75 buses/hour/direction; 20,000 pedestrians/day</li><li>● Pre-scheme: 24-hour weekday flow &gt;20,000 vehicles</li><li>● 2010: 24-hour weekday flow = 18,300 vehicles (am peak hour 1,030; pm peak hour 1,080)</li></ul>
<b>Speeds</b>	Post-scheme mean speed 18 mph (85th percentile 24 mph)
<b>Road Safety</b>	36 months 'Before' record: 63 total collisions, of which 29 involved pedestrians or cyclists 19 months 'After' record (factored up to 36 months): 53 total collisions, of which 30 involved pedestrians or cyclists
<b>Costs</b>	£4.5 million (approximately £2.5 million Southwark Council; £1 million Department for Transport; £1 million Transport for London)

## Evaluation

### Benefits

Walworth Road now has the character and appearance of bustling high street. Anecdotal evidence indicates:

- a noticeable increase in footfall and in the number of pedestrians crossing
- a decrease in shop vacancies
- growth in the amount of time people spend in the street.

Considering the challenging economic conditions since the scheme opened, this is good news - although there is no supporting factual evidence.

Specific improvements include:

- better provision for pedestrians to cross according to their desire lines (see photo CS4)
- better provision for bus passengers in terms of the positioning, layout and prominence of bus stop 'pairs'
- easier pedestrian movement and a more visually pleasing street scene due to the removal of unnecessary street clutter and the creation of raised side street crossings (see photo CS11).



Photo CS11

The footways are not just less cluttered - they are also considerably wider. The most important, and obvious, transformation the scheme has brought is the reallocation of space away from motor vehicles.

Comprehensive repaving in consistent, simple and maintainable materials has given the district a positive and cohesive identity. The tree-planting programme softens the impact of traffic, and adds a welcome new element to the street's overall character (see photo CS9).

Throughout the scheme, kerb heights have been lowered and in places there is no kerb at all (see photo CS5). This reduces segregation between those on the footway and those in the carriageway - requiring them to be generally more aware of one another. However, some national user groups and Southwark's Access Officer maintain the

blurring of pedestrian and vehicle areas can cause problems for blind and partially sighted people. Tactile paving - 'Corduroy' - has been used to mark the boundary where there is no kerb.

### Problems

There have been a number of minor changes to resolve particular issues. Pedestrian crossings were originally paved in modular granite blocks. However, these failed to cope with the weight and flow of buses and had to be removed.

Although footway materials are durable and maintainable, the lack of agreement on an overarching street management plan has led to poor reinstatement of paving by utility operators, and some problems with refuse collection.

The scheme opened in April 2008, so it will be another year before sound conclusions can be drawn. Collision monitoring after six months painted a positive picture, although further analysis after 19 months was less conclusive - with some positive and some negative results.

The interim data shows:

- the total number of collisions reduced noticeably
- the proportion of collisions leading to people being killed or seriously injured increased, also noticeably.
- this increase has fallen more heavily on user groups usually considered less vulnerable, than on pedestrians and cyclists.

Collisions incurring personal injuries are more evenly distributed, rather than in clusters as before. As the scheme did away with much of the paraphernalia focusing pedestrian crossing in specific locations, this is unsurprising.

### Conclusion

Despite the radical nature of the changes implemented on Walworth Road, the scheme is characterised by its pragmatism. This is evident throughout, from the reasons behind the public selection of the design team, through to the choice of materials. Walworth Road may look much different and better than it did previously - but the design fully responds to the practical and functional requirements of this very hard-working street.

### Further Information

<http://www.southwark.gov.uk>

<http://www.dft.gov.uk/pgr/roadsafety/dpp/mpr/>

### Project Team

- Project Management- London Borough of Southwark/Malcolm Reading Associates
- Public consultation- London Borough of Southwark
- Lead Designer - Project Centre Ltd
- Main Contractor - FM ConwayLondon



## 14.2\_ London Road, Southampton

### Summary

The improvements to London Road, to the north of Southampton city centre, were opened in September 2008. The scheme aimed to radically change the way in which London Road was used and understood, strengthening its friendliness to pedestrians, the visual quality of its public realm, and its sense of place. (See photo CS12 before and photo CS13 after.) The design adopted a minimalist approach to traffic management kit and other street furniture.



Photo CS12



Photo CS13

Southampton City Council intentionally associated the term 'shared space' with the scheme. However, it is perhaps best described as a 'better balanced' street, in which the needs of all users are now given appropriate consideration (see photo CS14 before and photo CS15 after). The council's aim was that the London Road design should be a quality benchmark for future work in the city - and it has succeeded in achieving this challenging objective.



Photo CS14



Photo CS15

### Description

London Road is an historic gateway to Southampton city centre for traffic arriving from the north (see Location Plan). The section covered by the scheme is around 450m long. It is home to around 80 businesses, mostly retail. It also has a developing café society and night-time economy, and is considered 'on the up' after years of decline.



Location Plan

Before the scheme, it was also a road safety hotspot, with 31 personal injury collisions recorded from 2002-2004, particularly affecting vulnerable road users. The degraded streetscape reinforced antisocial driver behaviour, and marginalised pedestrian movement along and across the street.

Southampton City Council's design team built on recent experience from European countries of 'shared space' approaches to street design. They placed a strong emphasis on innovative traffic management to reduce speed and improve walkability:

- carriageways were narrowed
- kerb heights were lowered
- the centre line and other superfluous road markings were removed.

Horizontal deflection (see photo CS16) was used to visually break the street into two sections, disrupting the traditional linearity. Parking was reorganised into discrete areas of echelon - angled - parking. Vehicles manoeuvring into and out of spaces increase 'friction' and help calm traffic speeds (see photo CS17).



Photo CS16



Photo CS17

A banned right turn at the junction with Brunswick Place – at the southern end of the scheme – has encouraged through traffic heading south towards the city centre to use the A33. This has led to reduced traffic volumes on London Road.

### Footways

Footways were widened - significantly in places - to give space for café seating and 'spill out' activity (see photo CS15). Street furniture and signs were rearranged into a furniture zone, so that pedestrian movement was not obstructed. Carriageway and footway lighting were combined to reduce the number of columns.

## Crossing Points

Informal pedestrian crossing points were implemented in three locations, using a change in materials and layout - but no traffic management signs or measures. Flush kerbs and granite sett paving were used on the carriageway to indicate the crossing (see photo CS16). Build outs and informal crossing points associated with angled parking (see photo CS19B)

## Public Transport

Bus stop improvements like raised kerbs (see photo CS18), new bus shelters and better information have significantly improved the public transport user experience. Bespoke Southampton wayfinding signs were piloted in London Road, and are due to be rolled out across Southampton.



Photo CS18

## Seating

Bespoke seating was designed by a local artist, focusing on the history of London Road (see photo CS19). Two large seats replicate the shape of the main rose window of St Paul's church, which formerly stood in London Road.



Photo CS19B

## Design Process

### Scheme genesis

The 2000 Southampton city centre masterplan identified the need to improve London Road as part of a wider strategy to upgrade the Queen Elizabeth II (QEII) Mile north-south spine. This links the waterfront to the retail and civic cores of Southampton.

### Procurement

An interdisciplinary in-house team delivered the project from inception through to construction. This team was supported by specialist consultancy advice on street lighting, public art and legibility aspects.

### People/disciplines involved

The City Council team included an urban street and landscape designer, transport engineers, transport planners, a city centre manager, parking services, marketing and public relations professionals. The team worked together to foster new ideas about street design and to challenge traditional thinking. A communications plan was used to:

- Keep people informed
- invite views on proposals
- build support for the project
- actively manage participation

### Notable issues

A 'Placecheck' survey was done in 2004 to find out how local businesses and residents thought London Road should be upgraded. The design team then developed an overall vision and concept for the street, and took the concept 'on the road' using a mobile exhibition space within a bus.

Adjoining landowners and tenants were engaged on a one-on-one basis. This aimed to help them understand the scheme, allay any concerns, and work through the complexities of construction programming. Post-consultation and approval of the design, regular newsletters, updates and thank you letters were sent to maintain communications.

The lead designers developed solutions that were different and challenging. The experience has helped to build council officers' capabilities and capacities to deliver similar schemes throughout the city.

Complex issues of parking and loading along the street were adequately resolved.

- Third-party parking forecourts to the south of the street were successfully integrated into the street design, while retaining the primacy of the footway for pedestrians.
- Designated cycle lanes within the street were initially proposed, but these were removed in favour of encouraging cyclists to share the main carriageway. Part of the reason for this was possible conflicts between cyclists in the lanes and vehicles manoeuvring into and out of the angled parking bays.

### Funding

Council officers got approval for improvements to London Road on the basis of benefits to road safety, public transport, walking and cycling. Local transport plan funding was obtained to address these issues in a single package.



Photo CS19

### Technical Data

<b>Dates</b>	Construction: June 2007-August 2008
<b>Volumes</b>	<ul style="list-style-type: none"> <li>• 2005 Pre-scheme: 24-hour weekday flow = 12,716 vehicles (am peak hour 764; pm peak hour 950)</li> <li>• 2010 Post scheme: 24-hour weekday flow = 7,260 vehicles (am peak hour 432; pm peak hour 559)</li> <li>• Post-scheme counts: pedestrians 5,500/day; cyclists 400/day</li> </ul>
<b>Speeds</b>	<ul style="list-style-type: none"> <li>• Post-scheme mean speed 18 mph (85th percentile 23 mph)</li> </ul>
<b>Road Safety</b>	2003-2006 inclusive (48 months): 31 collisions (28 slight; 3 serious) Jan-Dec 2009 (10 months): 3 collisions (all slight)
<b>Costs</b>	£1.3 million (works and fees for all phases)

### Evaluation

#### Benefits

The London Road improvement scheme has had a marked impact on the way people use and appreciate the street. It has transformed a once failing space into a worthy gateway to the city.

Simple lines and a clean finish give the street a sense of purpose (see photo CS13). The well considered layout of public realm elements emphasises the mixed-use nature of the street. A series of public spaces provides a setting for new public activities to happen in the street.

The design has used horizontal deflection (see photo CS16) of the carriageway alignment to create two precincts - north and south - of different character, and to reduce traffic speeds. The deflection is reinforced by short rows of parking in angled bays on alternating sides.

Angled bays can be awkward for crossing pedestrians to negotiate. However, the consolidation of parking, and the loss of some spaces overall has opened up new areas for pedestrian crossings with unobstructed sight lines (see photo CS16). Together, the horizontal deflection and new parking arrangements help to interrupt traffic flow and limit speeds. In turn, this helps create gaps in the flow so pedestrians can cross without formal signal control.

A representative of the local access forum commented how the scheme has 'settled down' since opening. Visually impaired people have got used to some particular features – such as raised tables – having previously had misgivings. It helped that certain design details – for example kerb heights - were tested in a mock-up at a

council depot, before progression within the overall design.

### **Problems**

It is perhaps unavoidable, given the scheme's remit and the nature of the roads which London Road connects to both north and south, that the improvements come to a very abrupt end at the scheme's 'red line'. For example, the staggered pedestrian crossing at the southern junction of London Road and Brunswick Place still acts as a barrier to pedestrian movement to and from the city centre. Reduced traffic flow on London Road means that in hindsight an un-staggered crossing should have been installed.

Although costs prohibited this, the design team would have preferred to have gone with a higher specification lighting column - the visual qualities and frequency of the columns used means they do tend to dominate the street. Tree planting on the eastern footway would have softened the impact of lighting columns, and balanced vertical elements along the street. However, the cost of relocating utilities was too high.

### **Conclusion**

Despite the economic climate, pedestrian footfall on London Road has increased. Early results suggest that both traffic speeds and the number of collisions have been reduced.

Overall, the London Road scheme has considerable lessons to offer. The project has showcased how in-house design teams are capable of taking ownership of - and delivering - high quality street improvement schemes, in challenging urban 'main street' conditions. A simple yet aesthetically pleasing design has been achieved without major cost in terms of materials. It is both affordable and replicable across Southampton, and in similar locations across the UK (see photo CS18).

### **Project Team**

- Designer: Simon Taylor, City Projects, Southampton City Council
- Project Manager: Phil Marshall, Southampton City Council
- Project Engineer: Graham Redman Southampton City Council
- Site Engineer: Nigel Best Southampton City Council
- Principal Contractor: A Machola Ltd
- Public Artist: Christopher Tipping
- Street Lighting: Halcrow Group Ltd
- Legible City Design: City ID

## 14\_ Case Studies

### 14.3\_ Sheaf Square & Howard Street, Sheffield

#### Summary

Sheffield's 'Gold Route' (see Location Plan) is a series of streets and places running through the city centre from Sheffield Station to the east, through to the Heart of the City to Devonshire Park in the west. Identified in the 2000 City Centre Masterplan, it has contributed a range of city centre regeneration schemes, and has been a focus for public investment to turn the historic tide of city centre decline.

Sheaf Square and Howard Street are two key elements of the Gold Route that connect Sheffield Station to the city centre, by incorporating new crossings of what were two distinct parts of Sheffield's relief/ring road system (Sheaf Street and Arundel Gate). They have transformed the sense of arrival in the city for many visitors, and greatly improved the setting for Sheffield Hallam University.

They exemplify the successful relationship that can be struck between an area's historic character and heritage and its emerging purposes and community. Although the scale of change may be beyond the reach of most Councils, they demonstrate what is achievable when the potential contribution of public realm to city regeneration is recognised and a commitment to joined-up design and integrated delivery and management structures is established.

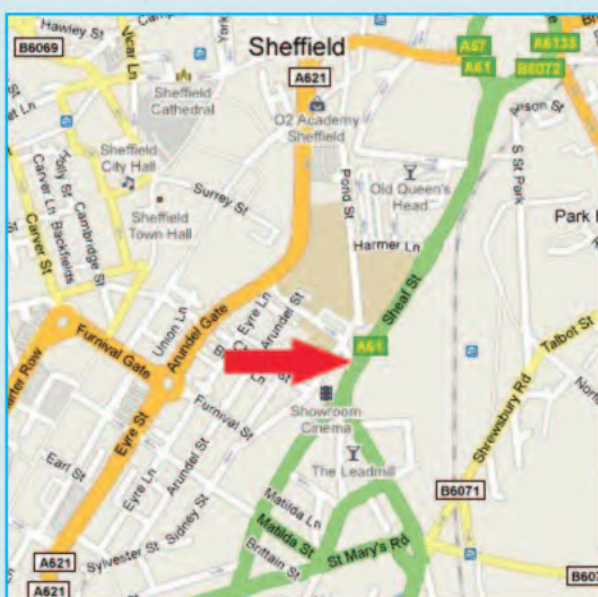

Location Plan

### Description

Sheaf Square was once dominated by Dyson House (see photo CS20) – a disused part of the Hallam University Campus, and separated from the centre by the heavily

trafficked Ring Road (Sheaf Street) (see photo CS22) and a large roundabout. Pedestrian connections to the city centre from the station were unpleasant, indirect and illegible (see photo CS21).



Photo CS20



Photo CS21



Photo CS22

Howard Street and Sheaf Square have been redesigned to create a much better 'first impression' of Sheffield and to reinforce one of the city's major pedestrian axes. Both were constructed at the same time as the major reshaping of the station itself.

### Sheaf Square

Demolition of Dyson House made a much enlarged square possible and opened up two parcels of land for major redevelopment (see photo CS23). The walking route between the station and Howard Street now runs between a water cascade and a gigantic stainless steel sculpture 'The Cutting Edge' that frame a gentle slope to the realigned and redesigned crossing of Sheaf Street. The sound of the water and the form of the sculpture blocks out any traffic noise.



Photo CS23



Photo CS24

The Ring Road itself has been substantially remodelled between Sheaf Square and Howard Street so that a wide, direct signalised crossing of the main carriageway is now on the exact alignment between the two spaces (see photo CS24) and a second, informal crossing of Pond Street/Paternoster Row (see photo CS25). This street narrows at the raised crossing point, so that only one vehicle can pass at a time. Vehicles give way to one another and pedestrians have a short crossing distance to negotiate. This bus gate has experienced vehicle/pedestrian conflicts and is currently under design review including looking at ways to reduce bus speeds.



Photo CS25

### Howard Street

Howard Street, which runs up the side of a valley, was previously dominated by traffic access and servicing in conflict with high flows of pedestrians (see photo CS26 before). Access to Pond Street/Paternoster Row was restricted to buses and local access traffic and Howard Street restricted to pedestrians and cyclists only.



Photo CS26

Howard Street itself is now a tree lined avenue with 12 illuminated stainless steel and granite seats (see photo CS27). The street is paved in a mix of flamed granite flags and sandstone with flush kerbs along the alignment of the old carriageway (see photo CS28 and photo CS29). The street is a shared surface for pedestrians, cyclists and occasional vehicles accessing the University front entrance. As elsewhere there is ongoing discussion about the design of such spaces in relation to use by people with visual impairments. Alongside, Hallam Gardens was created (see photo CS30) by the University entrance and consists of a simple terraced garden edged by a curved and ramped stone sitting wall containing a small water feature.



Photo CS27



Photo CS30



Photo CS31



Photo CS28

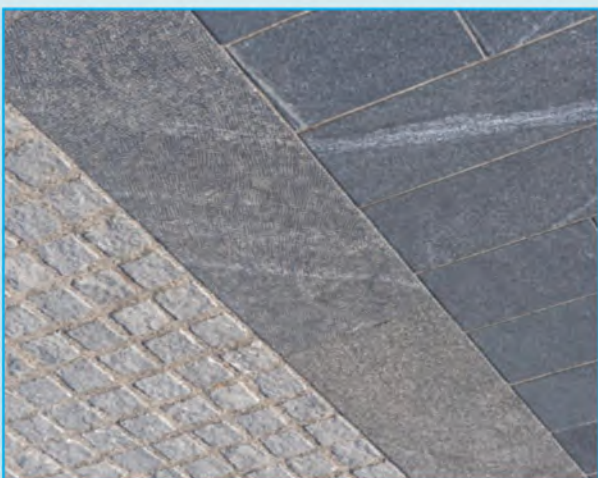

At its upper end, Howard Street connects with Arundel Gate, previously a dual carriageway 'concrete collar'. Formerly, the pedestrian route across Arundel Gate was via a subway. In association with the redesign of 'Hallam Square' in front of the main University entrance, there is now a signalised surface level crossing across a two-lane carriageway (see photo CS31).

**Design Process**  
**Scheme Genesis**

The 'Gold Route' emerged from the City Centre Masterplan, with the Sheaf Square, Howard Street and related projects identified as having a particular role to play in re-connecting the city centre with its mainline railway station. The Novotel building which is on the direct line between Howard Street and 'Hallam Square' represented an 'immovable object' and, in order for the route, to achieve its primary objective, the improvements would have to exhibit excellence in its design.

**Procurement**

Initial city centre masterplanning was carried out by EDAM, working with the City Council's in-house Regeneration Projects Design Team (RPDT) who went on to design and detail the scheme.

**People/Disciplines Involved**

Critically, the public realm and pedestrian interventions were progressed within a wider programme of city centre regeneration and involved the collective working of a range of public institutions, asset/service managers, and private land owners. Through collaborative working and investment the Gold Route projects have been so successful in stitching together the station with the Heart of the City and beyond.

**Notable Issues**

The successful regeneration of the Peace Gardens and the Heart of the City projects helped to generate support and commitment to further projects from politicians, council officers and the public generally. Council restructuring led to the creation of a single directorate and committee dealing with both transport and planning projects for the city, enabling more integrated and consistent decision making.

Both the Masterplan and detailed designs for each project area were the subject of extensive public consultation and engagement, especially with the users and operators of the station and of Hallam University Campus.

Subsequently development of sites and spaces around the Sheaf Square and Howard Street were the subject of further consultation as part of the development of the Sheaf Valley Masterplan, which was later incorporated in to the 2008 City Centre Masterplan Review.

The management of Sheaf Square and Howard Street is supported by the City Centre Management Team, whose work ensures that the Council holds National Beacon Council status, and whose roles include cleaning, water feature maintenance, horticulture, City Centre Ambassadors and security (see photo CS32).



Photo CS32

Overall, the success of the Gold Route programme and associated projects has been the consequence of committed leadership by the City Council, based on a clear and agreed vision for change that was conceived of and promoted as essential to the future success of the City. Continued commitment to this vision at the highest level helped to ensure the necessary interdisciplinary working within the Council, to which members remained committed despite possible concerns about cost, and that the many vital partnerships with other parties and agencies were well managed. The Gold Route is a great example of what genuine civic leadership can achieve in the 21st century.

**Funding**

Sheaf Square was linked to the refurbishment of the railway station, and was implemented and funded through a partnership comprising Sheffield 1 (Urban Regeneration Company), the City Council, Network Rail, Midland Mainline, the Department for Transport, Yorkshire Forward (Regional Development Agency) and the South Yorkshire Passenger Transport Authority. The regeneration and pedestrianisation of Howard Street and Hallam Square was delivered in partnership with, and in cases only made possible by, the efforts of Hallam University.

**Technical Data**

Dates	Construction: June 2007 to August 2008
Volumes	<p><b>Sheaf Street</b></p> <p>7am-7pm vehicle counts: 2001 – 36,600 2008 – 29,200 2010 – 25,520</p> <p>24-hour weekday flow: 2010 – 33,000</p> <p>7am-7pm pedestrian counts: 2001 – 3174 movements at previous roundabout 2008 – 8700 movements in same broad area</p> <p><b>Arundel Gate</b></p> <p>7am-7pm vehicle count: 1990 – 24,000 2010 – 11,780</p> <p>24-hour weekday flow: 2010 – 15,520</p> <p>Sheaf Street: post-scheme mean speed 23mph (85th percentile 29mph) Arundel Gate: post-scheme mean speed 21mph (85th percentile 25mph)</p>
Speeds	
Road Safety	<p>Sheaf Street/Pateroster Row (vicinity of Howard Street/Sheaf Square)</p> <p>Before – 1/04/00-1/04/04 (48 months): 18 collisions (16 slight; 2 serious) After – 1/04/08-31/1/10 (22 months): 10 collisions (all slight)</p> <p>Arundel Gate (vicinity of Howard Street)</p> <p>Before – 1/04/00-1/04/04 (48 months): 7 collisions (3 slight; 3 serious; 1 fatal) After – 1/04/08-31/1/10 (22 months): 4 collisions (3 slight; 1 serious)</p>
Costs	<p>£24 million (£11.1m European 'Objective 1' funding; £6.8m DfT; £2.8m Yorkshire Forward; £3.3m from Hallam University, s106 contributions, English Partnerships, Railway Heritage, private developers)</p>

## Evaluation

The regeneration of Sheaf Square and Howard Street has delivered seamless and legible connections between key points in the city centre (see photo CS31 and photo CS24). The reflection of history, culture and enterprise in their layout, form and aesthetic give them meaning and purpose.

In terms of transport, the reconfiguration of the Ring Road and the downgrading of the infamous concrete collar have not only been essential to the transformation in Sheffield but can also act as inspiration to the many other UK cities and towns that suffer from the stifling of growth and development that such highway infrastructure leads to. The concerns about gridlock in Sheffield that were once voiced at the prospect of the changes, though they were understandable, have proved unfounded.

A few concerns about the scheme design have been raised from an accessibility perspective. These include the design of some seating without backs or arms, an issue that has since been resolved. The sharing of Howard Street by pedestrians and cyclists remains a potential concern in relation to the safety of the former, and this is an aspect of the scheme that is presently being monitored to see if remedial action – perhaps simply through access management rather than design – is required.

The cost of these improvements, while justified by experience, may be considered beyond the ability of other Councils to afford. Nevertheless, the Gold Route demonstrates the need for an institutional framework and process to guide wider city centre regeneration. The partnership between the Council and Hallam University in the delivery of improvements to Howard Street and Hallam Square, and between the Council and Network Rail in joining-up the station redevelopment and Sheaf Square project, show how such mechanisms are necessary in creating better functioning, formed and designed spaces.

Four years on from opening, both Sheaf Square and Howard Street remain in good condition. This would not have been the case had the Council not learnt lessons with preceding schemes such as the Peace Gardens. The major water features in Sheffield were installed with a clear understanding of, and commitment to, a lifecycle maintenance regime capable of keeping features such as those in Sheaf Square and Hallam Gardens in excellent working order.

The City Centre Management Team (CCMT) is key to the ongoing success of the public realm investment (see photo CS32). Specific service level agreements on maintenance standards and budgets are based upon the priority allocated to the location of the street or space. These include a lifecycle asset management regime and

costs for cleaning, repair and reinstatement, and for the management of major public realm features.

Day-to-day management of the spaces is enhanced by the presence of the CCMT Ambassadors. There are excellent working relationships with the local police, and this partnership allows for the sharing of responsibilities of public space management.

Successful partnerships; inspired and committed leadership; design excellence; the prioritisation of pedestrian movement over vehicular movement where appropriate; and a clear ongoing maintenance and management regime. All of these have been essential to the success of Sheaf Square and Howard Street in achieving genuine benefits for the users of the spaces and Sheffield as a whole.

## Project Team

- Lead Designer – Sheffield City Council Regeneration Projects Design Team with support from EDAW and Faber Maunsell
- Main Contractor – Interserve
- Lighting – Sutton Vane
- Highways Design – Street Force
- Artists – Si Applied ('Cutting Edge' sculpture); Jeremy Asquith (street furniture); Mosaic Workshop (Howard Street Rill); RPDT (Sheaf Street Water Cascade)

## 14.4\_ High Row & West Row, Darlington - Part Of The 'Pedestrian Heart'

### Summary

The Darlington 'Pedestrian Heart' project opened in summer 2007, following more than two years of physical work in the town centre. Darlington wanted to maintain its competitive edge as one of the main shopping destinations in the Tees Valley. The scheme aimed to bring people back, encourage an improved retail offer, and attract new investment and development in the town.

The scheme involved rationalising bus access (see photo CS33) and improving pedestrian provision within a large part of the town centre. It was focused around the historic market hall and market square, and included the unique three-level street at High Row/West Row. Bus routes were considerably reconfigured, with a bus-only gate maintaining excellent bus penetration into the centre. All private car parking is provided on the edge of the core.



Photo CS33

Over two years after opening, the scheme is considered a major success. Footfall has increased and the improvements have been cited as the reason why a number of significant retail landlords have invested further in the town. Darlington Pedestrian Heart is an example of how appropriate public realm investment can enable a market town to transform not only its image, but also the quality of life for its people (see Photo CS34).



Photo CS34

### Description

High Row and West Row lie parallel and immediately next to one another in Darlington's town centre (see Location Plan). They form part of what was once the Great North Road between London and Edinburgh. High Row was formed from a raised footway on the western side, separated from its carriageway to the east by a triple-stepped kerb. The whole was separated by a sloping bank from the lower West Row.

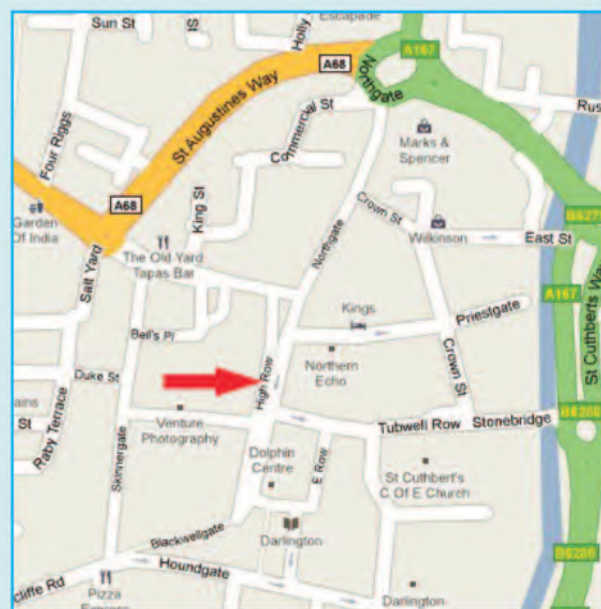

Location Plan

The layout dates back to 1904, when the street hosted a cattle market. Before the Pedestrian Heart improvements, traffic tended to dominate. There were access restrictions, including one-way operation and bus lanes. These were signed and enforced using conventional methods, which together with planters and associated paraphernalia created a poor impression. (see photo CS35)



Photo CS35

The dominance of the two carriageways, the lack of pedestrian facilities, and some vehicle congestion meant the space did not work well for anyone. Darlington Borough Council saw an opportunity to create a focal point for civic and market activity (see photo CS36).



Photo CS36

A critical challenge was to reorganise provision for different modes to stop vehicles 'choking' the town centre streets, particularly along High Row and West Row. Bus stop capacity and layover space were issues, given increasing numbers of bus patrons and bus mode share. Bus routes and interchange facilities were relocated, but remained very close to the retail core (see photo CS33).

This enabled vehicles to be effectively excluded from West Row. Service access to High Row was restricted to before and after retail trading hours. These changes allowed the three levels to be rationalised to two and the creation of a predominantly pedestrian space. The upper - High Row - carriageway was raised to footway level,

creating a single surface. In the lower section - West Row - the distinction between footway and carriageway was also largely removed (see photo CS34). It is now effectively a pedestrianised street. The level change between the two streets is the defining feature within the town centre which has been celebrated and articulated through a single flight of steps that runs the entire length of the space (see photo CS37).



Photo CS37

The steps terminate at the junction of West Row and Northgate to the north of the scheme with a new amphitheatre and focal point for civic gatherings and events (see photo CS39). The removal of traffic outside the market hall allowed for the relocation of the outdoor market to a primary location within the town centre. A similar market/events space was created to the south along Blackwell Gate.



Photo CS39

One of the scheme's most interesting features is the 'stepped water cascade' developed by Gillespies, Fountain Workshop and artist Michael Pinsky (see photo CS40). This water feature sits under the main pedestrian ramp linking High and West Rows, and is made from coloured strips of granite. Alternate grey and red lines reflect both the historic washing of blood down the slope associated with the earlier market, and the 'barcode' pattern that underpins contemporary trading.

### Design Process

#### Scheme genesis

The Pedestrian Heart scheme emerged from the 2001 town centre development strategy. The strategy aimed to make a distinct improvement in the economy and quality of the environment in Darlington town centre. It had two main strands:

- to attract new retailers and businesses
- to increase the ease, comfort and safety with which the town centre could be used.

#### Procurement

A 2001 town centre access study identified the opportunity to create a 'pedestrian heart'. The proposal was approved by Darlington Borough Council in 2002. Gillespies were appointed in 2003 as lead consultants to take forward the design development. The Pedestrian Heart project therefore pre-dates Darlington's sustainable travel demonstration town initiative.

#### People/disciplines involved

Design development and delivery was helped by all the key contributing officers being within the same division. Transport officers in particular made a positive contribution to negotiations with bus operators. The process was also aided by strong buy-in from council members, and the council's general political unity.

Despite not having a formal role in project execution, a steering group of council members ensured that members remained informed and supportive throughout. Without this well co-ordinated project management and governance regime, some of the more controversial aspects of the scheme – such as the water feature and inclusion of cyclists – would have been lost.

Public and focused stakeholder engagement was a crucial component throughout the process. This included very close working with town centre businesses to minimise construction disruption, and with the Darlington Access & Disability group on inclusive design.

#### Notable issues

In such a historic location, there was understandable concern about the nature and scope of change. Local heritage groups were particularly concerned about the change from the previous three levels to two (see photo CS37). This was addressed by outlining the benefits of the new layout, and by that the fact that the new scheme would be reinstating the original simpler layout that was in place pre 1904.

Significant disruption to local businesses during the construction period was recognised as inevitable. A dedicated liaison officer was appointed. Whose efforts in building personal relationships with retailers and market traders were key to maintaining their support. A major gas main was encountered beneath West Row during construction, and this had a significant impact on scheme design and costs. It also added three months to the construction period.

During design development, there was considerable discussion about the initial plan to allow cyclists to use the pedestrian area informally. The close working relationships and trust between officers and members meant that, despite opposition based on safety concerns, cyclists were permitted to use the scheme on opening. This was initially for a six-month trial period. Based on experiences during this period – during which CCTV-based assessment of pedestrian-cyclist interactions took place – the decision to allow cycling within the Pedestrian Heart area was made permanent.

Concerns were expressed by blind and partially sighted people about the loss of kerbs in some locations. This was addressed partly by varying certain design details. The very low vehicle volumes and speeds that would be encountered in what is a virtually pedestrianised part of the town centre were also pointed out.

## Funding

The Pedestrian Heart scheme was largely funded by:

- Darlington Borough Council
- the Local Transport Plan and
- One North East (the regional development agency) 'Single Programme' funding, through the Tees Valley Partnership.

## Technical Data

<b>Dates</b>	Construction: 2005 – Summer 2007
<b>Volumes</b>	Prebend Row 2010: 24-hour weekday flow = 2,020 vehicles (am peak hour 130; pm peak hour 160)
<b>Speeds</b>	Post-scheme mean speed 13mph (85th percentile 17mph)
<b>Road Safety</b>	No personal injury collisions involving pedestrians or cyclists were recorded within the town centre ring road in the year following scheme completion.
<b>Costs</b>	£6.5 million (approx) (£3.3 million One North East; £2.5 million Darlington Borough Council; £0.65 million Local Transport Plan)

## Evaluation

Perhaps the most important mark of the Pedestrian Heart scheme's success is that, despite the economic recession, the town centre economy is showing signs of resilience. Pedestrian footfall and parking duration of stay figures improved between 2008 and 2009, in contrast to other centres in the Tees Valley. Darlington's town centre manager reports greater investor confidence in Darlington as an investment location - though objective data to support this is not available.

## Benefits

The design has delivered numerous benefits:

- The upper section exploits the east-facing orientation and elevated position relative to the rest of the town by incorporating new areas of seating, and a wide, flush, retail and civic promenade.
- The scheme maintains good access to the centre for public transport and for people with disabilities.
- Space has been created for the market traders to be located on the main retail street to provide vitality and greater choice to the town centre offer.
- Planters have been integrated into a retaining wall between the upper and lower sections, breaking up the hard urban condition and facilitating Darlington's ongoing participation in 'Britain in Bloom' (see photo CS39)

- Cycling levels in the town centre have increased since the scheme opened, with the number of cyclists counted over a 12-hour period rising from around 1,000 in July 2007 to over 1,300 in July 2008
- Support from people in the town centre for allowing cycling to continue has also increased over the same period, from 53.9% to 62.1%.

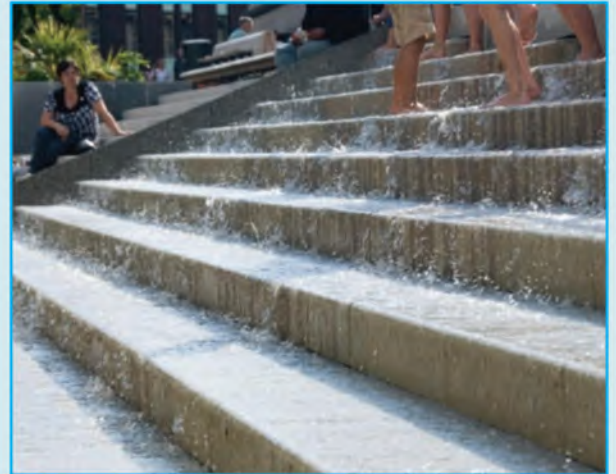

Photo CS40

The scheme was ambitious, with a clear vision for transformation and a strong emphasis on creating a quality environment for pedestrians. It has successfully achieved an appropriate balance between various modes of travel. The greatly enhanced public realm has created both a safer and more attractive environment for all users, and a more flexible space for markets and events.

## Problems

As might be expected with such a major scheme, a number of issues were encountered in the development and construction phases. Engagement with businesses was a major issue:

- the 18-month period of design development meant that several consultees moved on during the process
- some felt that more could have been done to get the people of Darlington excited about the project - what the 'gain' would be for the construction 'pain'.

Project cost increases and overrun, largely due to the problems associated with the gas main under West Row, meant that compromises were made in relation to some of the design features. There have also been maintenance problems associated with some of the more complex elements.

### Conclusion

Darlington Pedestrian Heart has nevertheless achieved its primary objective of bringing people back to the town centre - and encouraging them to stay there longer. The heart of the town now throngs with people – whatever the weather. It's still easy to get to by bus, and businesses are doing well. High Row and West Row no longer look or work like the historic Great North Road did, but what this part of Darlington needed then and needs now is quite different. The Pedestrian Heart is a benchmark for the town – and other market towns – for the early 21st century (see photo CS36 and photo CS37).

### Further Information

<http://www.darlington.gov.uk/Living/Planning+and+Building+Control/Planning+Services/Projects+and+Schemes/PedHeart/PedestrianHeart.htm>

### Project Team

- Lead Designer – Gillespies
- Main Contractor – Birse
- Artist – Mike Pinsky (Water Cascade and 'Life Pulse')
- Highway Engineers – Faber Maunsell
- Quantity Surveyors – Kinsler & Partners
- Lighting Design – Equation
- Water Feature Designer – The Fountain Workshop



## 14.5\_ Maid Marian Way, Nottingham

### Summary

Voted by the public as one of Britain's worst streets, Nottingham's Maid Marian Way has since been transformed from a traffic-dominated corridor into a more pedestrian-friendly part of the city.

Pedestrian subways under busy roads on the edge of city centres are a common legacy from the 1960s and 70s. In Nottingham, Maid Marian Way was turned into an inner-city dual carriageway in 1964. The intersection with Friar Lane was turned into a roundabout with a sunken plaza, which linked four pedestrian subways each served by stairways and ramps (see Photo CS41). There are similar examples in many other UK towns and cities.

In 1989, a review of planning policy for Nottingham city centre highlighted a number of essential measures to retain the city's competitive position for retail, business and tourism - including overcoming the barrier effect of Maid Marian Way. Consideration was given to sinking the road into a tunnel, but this was discounted on financial grounds (see Photo CS44).

Remodelling of the dual carriageway and the inclusion of wide pedestrian crossings has restored a direct visual and psychological link across the busy road (see Photo CS42 and CS43). Large areas of additional public space have been won back in the process, creating generous pavements and areas of planting.



Photo CS41



Photo CS42

### Description

Maid Marian Way runs from Canal Street/Castle Boulevard to the south, to the roundabout junction with Upper Parliament Street to the north – some 650m (see Location Plan).

It was previously laid out as a four lane dual carriageway that bore no direct relation to the surrounding urban fabric, and was designed primarily for moving large volumes of traffic. As a result it severed the parts of the city centre to west and east. It was lined by a mixture of older buildings and undistinguished office blocks from the 1970s and 1980s.



Location Plan

The centrepiece of the improvements is the treatment of the roundabout that formed the intersection with Friar Lane. A sunken plaza with sloping concrete walls surrounding a small retail kiosk connected four subways, which emerged through step/ramp arrangements on each of the four corners of the space (see Photo CS41). The available footway at each corner was reduced by this arrangement to narrow fragments close to the buildings.

### Crossings

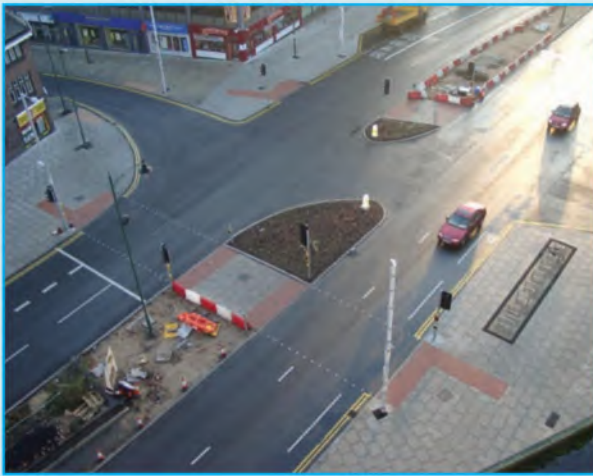

Photo CS43

The design involved filling the subways and sunken plaza with concrete. The roundabout was replaced with a set of traffic signals and two in-line pedestrian crossings over Maid Marian Way to the north and south of Friar Lane. The five metre wide crossings provide adequate space on the central median to allow them to be directly aligned with the dominant pedestrian movement. Generous new pavement areas were added, with side-street connections incorporated into the design (see photo CS43 and CS44).



Photo CS44

### Street furniture

Modern street furniture, including bicycle parking, was installed, with new tree planting along the footway. Traffic signal equipment was mounted on new lighting columns, with dedicated electrical supply for each to keep maintenance simple and safe (see photo CS45). The City Council also took the decision to omit the surrounding white backing boards for signal heads to reduce their impact on the streetscape at the junction.



Photo CS45

### Friar Lane junction

Although the speed limit - 30mph - and the basic dual carriageway layout remained unchanged, both approaches to the Friar Lane junction were redesigned with ramps as speed reduction features. Kerb heights at the junction itself were reduced to around 25mm.

The Friar Lane junction has been transformed, influencing how the whole of Maid Marian Way impacts on the surrounding built environment and on pedestrian movement. The street continues to carry broadly the same traffic volume as before.



Photo CS46

However, traffic capacity and horizontal alignment issues – for example at the Mount Street junction - along with awkward carriageway levels, have meant that a more conventional highway design has been used north of the Friar Lane junction (see Photo CS46). This includes significant lengths of guard rails, and staggered pedestrian crossings.

The introduction of bus lanes and a dedicated right-turning lane into Friar Lane (east) means that Maid Marian Way is now six lanes across in some places, compared with the previous four. However, the width of each new lane is less than the former lanes.

Further improvements are proposed for this northern section:

- the red tactile paving at junctions will be replaced with a less obtrusive colour
- significant lengths of pedestrian guard rails will be removed from the Mount Street junction as part of a wider city centre decluttering programme.

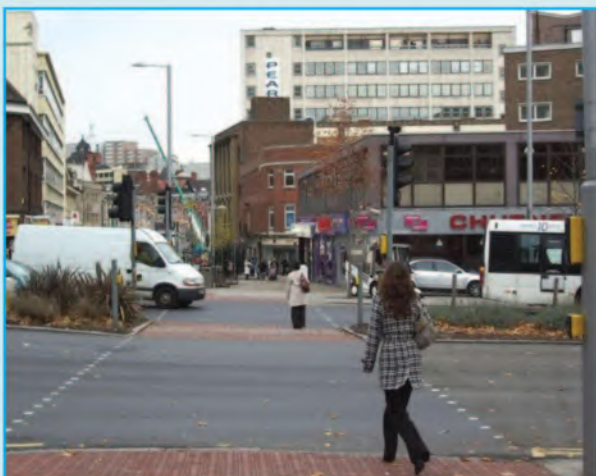

Photo CS47

## Design Process

### Scheme genesis

The changes in Maid Marian Way were part of a wider package of improvements. These aimed to reduce the severance created by the inner ring road in order to allow the city centre to expand. From the outset, it was recognised Maid Marian Way would need to continue to handle large volumes of traffic - so the focus was on how best to improve physical and perceptual links for pedestrians.

### Procurement

Funding was sought via a major scheme bid to the Department for Transport (DfT) - an 'Annex E' submission as part of the Local Transport Plan.

The focus on improved pedestrian movement and city centre environment meant that a conventional cost-benefit assessment rated the overall package as negative. This led to delays in the DfT approving the major scheme bid. However, Nottingham City Council pressed ahead with the implementation of the Maid Marian Way element, using general Local Transport Plan funding. The scheme was procured, designed and delivered entirely by Nottingham City Council.

### People/disciplines involved

Close working relationships between urban design officers, highway engineers and transport planners were achieved. Construction managers were included early in the design process, exploiting the opportunities of in-house contracting. The experience built confidence in council officers working together and managing large-scale schemes. This prompted the setting up of a city development team, to bring together a wide range of skills and professions.

### Notable issues

The project also gave momentum to a growing public and political interest in streetscape design. This led to the publication of a comprehensive streetscape design manual in September 2004, updated in August 2006. This has raised awareness of good design across the council, and among contractors, statutory undertakers, and other partners.

Communication and consultation involved some imaginative measures:

- a programmed series of events and meetings with businesses
- hotels promoting 'quiet days' during construction when noisy operations were avoided
- regular monthly meetings for bus and taxi operators, focusing on minimising disruption during construction
- articles written by a local food writer, observing progress from a nearby restaurant

- where tree planting had to wait until the appropriate season, the word 'tree' appeared across the temporary paving
- an imaginative series of handouts to keep the public informed, explaining the logic of the scheme
- a programme of artworks and events celebrating the new pedestrian connection.

The multi-disciplinary in-house team meant a more informed approach to safety auditing than might otherwise have been expected. After extensive discussions, traffic movements at the Friar Lane junction were simplified, with no vehicles entering Maid Marian Way from Friar Lane. This enabled road safety officers to feel confident with the proposals. Other technical challenges included the use of 'puffin' pedestrian crossings, and providing an adequately wide central median. This meant a direct - as opposed to staggered - pedestrian route could be provided, linking the two separate signalised crossings (see photo CS47).

#### Funding

The £2.9 million cost of the Maid Marian Way scheme was met through Local Transport Plan funding and by the East Midlands Regional Development Agency - specifically for environmental enhancements. An additional £11.7 million of Local Transport Plan funding became available by 2003 to support a wide-ranging strategy for Nottingham's city centre called 'Turning Point'. The scheme for Maid Marian Way was also part of the city's 'Big Wheel' transport plans for Greater Nottingham.

#### Technical Data

<b>Dates</b>	Scheme construction began in May 2003 and was substantially completed by August 2004.
<b>Volumes</b>	2010: 24-hour weekday flow = 27,840 vehicles (am peak hour 1,970; pm peak hour 1,960)
<b>Speeds</b>	Post-scheme mean speeds (north of Friar Lane): northbound 24mph (85th percentile 28mph); southbound 16mph (85th percentile 21mph)
<b>Road Safety</b>	Analysis of accidents has shown no detriment to safety as a result of removing the guard rail. In each of the years 2000-2002, there was a single Vulnerable Road User (VRU) casualty at the Friar Lane junction (a cyclist in all three cases). There were no VRU casualties in 2003-2005, but a total of six VRUs in the three years 2006-2008, comprising four pedestrians, one cyclist and one motorcyclist. Of the four pedestrian casualties, three were intoxicated at the time and the fourth was a child walking down the carriageway backwards.
<b>Costs</b>	£2.9 million (£2.35 million from Local Transport Plan; £650,000 from Regional Development Agency for environmental enhancements)

#### Evaluation

##### Benefits

The remarkable transformation of Maid Marian Way highlights the effort required to overcome the worst legacies of segregation as a highway design philosophy. It also shows how changing the highway alone can't change the whole place:

- the architecture and urban design of the surroundings do little to foster a distinctive sense of place
- much remains to be done to integrate the street into the fabric of Nottingham.

Nevertheless, a street identified as one of the least loved in the country has been transformed into a legible and functional space. In comparison with its previous layout, its barrier effect is largely overcome.

A survey of pedestrian movements between April 2003 and April 2005 suggested that the Friar Lane route across Maid Marian Way has attracted considerably more people: a 56 per cent increase in weekday pedestrians and a 29 per cent increase among Saturday shoppers. It

feels comfortable to cross the busy road - a pedestrian journey across Maid Marian Way is no longer the hostile experience it once was.

### Problems

The scheme involved the clearance of the previous planting on the median to the north and south of Friar Lane. This was due to the reduction in width of the median itself, and to increase the visual connection across the street. However, this meant the loss of some mature trees. Although 80 new trees were planted on both the median and the - now wider - footways, it will be some years before they have grown enough to provide enclosure for the street.

There were problems with the new low-level planting between the trees on the median. The 2004 planting scheme was not strong enough to withstand winter salting, and failed to restrict pedestrians from crossing in mid-block locations. It was replanted with denser vegetation, coupled with a 1m-high 'post and wire' fence to stop pedestrians crossing until the planting could become established.

Although transformed from its former configuration, the central junction still feels highly engineered. Greater emphasis could have been given to the continuity and importance of Friar Lane, stressing the connection between castle and city centre without compromising safety or traffic flows on the main road. An integral tactile language as part of the overall design would have been preferable – and this is now to be addressed.

### Conclusion

The Maid Marian Way scheme kick-started a positive change to Nottingham's public image that was taken on by the rest of the Turning Point project. Tackling the worst aspects of Maid Marian Way was an essential component in reconnecting the fabric of the city. This project demonstrates what can be achieved by bringing together the skills and imagination of several professions to rebalance the multiple functions of streets and public spaces.

The scheme demonstrates how problem inner city ring roads can be transformed. However, it also highlights – for example at the Mount Street junction – the tensions that still exist between traffic capacity and safety concerns, and the desire to deliver more walkable and high-amenity streets.

Some of its worst attributes have been removed and high quality connections have been provided. However, more work is required for Maid Marian Way to become an urban boulevard that is supportive of the full range of city centre movement patterns and other activities.

Maid Marian Way remains perhaps the best UK example of a ring road that has been transformed despite retaining its strategic traffic function. Maid Marian Way shows how – with a strong, shared commitment to change – soulless traffic conduits can be made into lively city streets.

### Further Information

- Turning Point (<http://www.nottinghamcity.gov.uk/index.aspx?articleid=2805>)
- Big Wheel (<http://www.thebigwheel.org.uk/>)

### Project Team

- Ben Webster, Urban design officer
- David Jones, Modelling, appraisal & business case
- Bob Bolus, Project manager
- Alan Solaini, Traffic signals design team leader
- Sarah Clarke, Communications officer
- John Hardy, Senior engineer, Highway design
- Chris Keane, Senior engineer, Highway design
- Francis Ashton, Road Safety Manager, Environment and Regeneration
- Nigel Turpin, Urban design team leader
- Brian Etherington, Site agent for highways construction

## References

- 1 Mixed Priority Routes: A Practitioners Guide, Local Transport Note 3/08, Department for Transport, 2008
- 2 DfT Shared Space Project - Stage 1: Appraisal of Shared Space, MVA Consultancy, 2009
- 3 Design Manual for Roads and Bridges Volume 6 Section 2, TD41/95, Vehicular Access to All-Purpose Trunk Roads, Highways Agency, 1995
- 4 Rediscovering Mixed-Use Streets: The Contribution of Local High Streets to Sustainable Communities, Joseph Rowntree Foundation, The Policy Press, 2007
- 5 Paved with Gold the Real Value of Good Street Design, Commission for Architecture and the Built Environment, 2007
- 6 Link and Place: A Guide to Street Planning and Design, Landor Publishing, 2008
- 7 Highways Asset Management Plan, London Borough of Hounslow, 2009
- 8 Understanding Place Historic Area Assessments: Principles and Practice, English Heritage, 2010
- 9 Understanding Place: Historic Area Assessments in a Planning and Development Context, English Heritage, 2010
- 10 Cycling in Pedestrian Areas, Traffic Advisory Leaflet 9/93, Department for Transport, 1993
- 11 Cycling in Vehicle Restricted Areas, TRL Research Report 583, TRL, 2003
- 12 Suburbs and the Historic Environment, English Heritage, 2007
- 13 The Boulevard Book: History, Evolution, Design of MultiWay Boulevards, MIT Press, 2003
- 14 Better Rail Stations, An Independent Review Presented to Lord Adonis, Secretary of State for Transport, Department for Transport, 2009
- 15 Pedestrian Environmental Review System Version 2, Transport Research Laboratory, 2010
- 16 Walking Good Practice Volume 3, Transport for London, 2010
- 17 10 Big Numbers, Commission for Rural Communities, 2009
- 18 Managing Dorset's Rural Roads: Our New Approach to Road Management in a High Quality Environment, Dorset County Council, 2008
- 19 Devon County Council
- 20 Streets for All Practical Case Study 6: Tactile Paving, English Heritage, 2008
- 21 Highway Risk and Liability Claims, UK Roads Board, 2009
- 22 The Highway Code, Department for Transport, 2007
- 23 The Manual for Streets: Evidence and Research, TRL Report 661, Transport Research Laboratory, 2007
- 24 Traffic Management and Streetscape, Local Transport Note 1/08, Department for Transport, 2008
- 25 Better Streets, Mayor of London, 2009
- 26 Companion Document to Manual for Streets, Hampshire County Council, 2010
- 27 Planning Policy Statement 6: Planning for Town Centres, Office of the Deputy Prime Minister, 2005
- 28 Planning Policy Wales, Technical Advice Note 12: Design, Welsh Assembly Government, 2009
- 29 Streets for All, English Heritage, 2005
- 30 Kent Design Guide Review: Interim Guidance Note 1: Quality Audits, Kent Highway Services, 2008
- 31 Solihull MBC
- 32 Road Safety Audit Guidelines, Institution of Highways and Transportation, 2008
- 33 Design Manual for Roads and Bridges Volume 5 Section 2, HD19/03, Road Safety Audit, Highways Agency, 2003
- 34 Hounslow Streetscape Design Guide, London Borough of Hounslow, Draft
- 35 Inclusive Mobility, Department for Transport, 2005
- 36 Providing for Journeys on Foot, Institution of Highways and Transportation, 2000
- 37 Planning Policy Wales, Technical Advice Note 18: Transport, Welsh Assembly Government, 2007
- 38 Cycle Infrastructure Design, Local Transport Note 2/08, Department for Transport, 2008
- 39 The Effect of Cycle Lanes on the Proximity between Motor Traffic and Cycle Traffic, Accident Analysis & Prevention, Volume 42, Issue 1, January 2010
- 40 Shared Use by Cyclists and Pedestrians, Local Transport Note 2/86, Department of Transport / The Welsh Office, 1986
- 41 Keeping Buses Moving, Local Transport Note 1/97, Department for Transport, Local Government and the Regions, 1997
- 42 Bus Priority: The Way Ahead, Department for Transport, 2004
- 43 Accessible Bus Stop Design Guidance, Bus Priority Team technical advice note BP1/06, Transport for London, 2006
- 44 Design Manual for Roads and Bridges Volume 6 Section 1, TD9/93, Highway Link Design, Highways Agency, 1993
- 45 Transport Statistics Bulletin, Road Statistics 2008: Traffic, Speeds and Congestion, Department of Transport, 2008
- 46 Setting Local Speed Limits, DfT Circular 01/2006, Department for Transport, 2006
- 47 Setting Local Speed Limits in Wales, Circular No. 24/2009, Welsh Assembly Government, 2009
- 48 Traffic Calming Techniques, Institution of Highways and Transportation, 2005
- 49 Design Manual for Roads and Bridges, Highway Link Design, TA43/84 (Withdrawn), Highways Agency, 1984
- 50 The Assessment of Pedestrian Crossings, Local Transport Note 1/95, Department for Transport, 1995
- 51 The Design of Pedestrian Crossings, Local Transport Note 2/95, Department for Transport, 1995
- 52 The Zebra, Pelican and Puffin Pedestrian Crossing Regulations and General Directions 1997
- 53 Safety Investigation at Pelican Crossing Sites, London Accident Analysis Unit, 1974
- 54 Design Manual for Roads and Bridges Volume 6 Section 2, TD42/95, Geometry Design of Major/Minor Priority Junctions, Highways Agency, 1995
- 55 Layout and Design Factors Affecting Cycle Safety at T-Junctions, Traffic Engineering and Control, October 1992
- 56 Design Manual for Roads and Bridges Volume 6 Section 2, TD16/07, Geometric Design of Roundabouts, Highways Agency, 2007
- 57 Cyclists at Roundabouts: Continental Design Geometry, Traffic Advisory Leaflet 9/97, Department for Transport, 1997

- <sup>58</sup> The Traffic Signs Regulation and General Directions 2002
- <sup>59</sup> Design Manual for Roads and Bridges Volume 6 Section 2, TD54/07, Design of Mini-Roundabouts, Highways Agency, 2007
- <sup>60</sup> Mini Roundabouts Good Practice Guidance, Department for Transport and County Surveyors' Society, 2006
- <sup>61</sup> General Principles of Traffic Control by Light Signals, Traffic Advisory Leaflet 1/06, Department for Transport, 2006
- <sup>62</sup> Pedestrian Facilities at Signal-controlled Junctions, Traffic Advisory Leaflet 5/05, Department for Transport, 2005
- <sup>63</sup> Design Manual for Roads and Bridges Volume 6 Section 2, TD50/04, The Geometric Layout of Signal-Controlled Junctions and Signalised Roundabouts, Highways Agency, 2004
- <sup>64</sup> Economic Impact of Traffic Signals, Greater London Authority, 2009
- <sup>65</sup> The Installation of Traffic Signals and Associated Equipment, Local Transport Note 1/98, Department of the Environment, Transport and the Regions, 1998
- <sup>66</sup> Research for MfS2 – High Risk Collision Sites and Y Distance Visibility, TMS Consultancy, 2010
- <sup>67</sup> UNECE Vehicle Regulation 1E/ECE/324 - E/ECE/TRANS/505, Rev.1/Add.12/Rev.6, United Nations Economic Commission for Europe,
- <sup>68</sup> Accidents at Three-Arm Priority Junctions on Urban Single-Carriageway Roads, TRL Report 184, Transport Research Laboratory, 1996
- <sup>69</sup> Parking Strategies and Management, Institution of Highways and Transportation, 2005
- <sup>70</sup> Car Parking: What Works Where Toolkit, English Partnerships, 2006
- <sup>71</sup> Kerbside Loading Guidance, Freight Unit Technical Advice Note: FU5/08, Transport for London, 2009
- <sup>72</sup> Streetscape Guidance 2009: A Guide to Better London Streets, Transport for London, 2009
- <sup>73</sup> Towards a Fine City for People, Transport for London and Central London Partnership, 2004
- <sup>74</sup> Making Space for Waste: Designing Waste Management in New Developments, Association of Directors of Environment, Economy, Planning and Transport, 2010
- <sup>75</sup> The Impact of Street Furniture on Pedestrian Movement, Paper to the 7th Transport Practitioners Meeting, 2009
- <sup>76</sup> Pedestrian Guardrailing, Local Transport Note 2/09, Department for Transport, 2009
- <sup>77</sup> Guardrail Assessment Form, Transport for London, 2007
- <sup>78</sup> Review of Criteria for the Provision of Pedestrian Guardrailing in the London Borough of Hackney, London Borough of Hackney and Urban Initiatives, 2007
- <sup>79</sup> Adapting Cities for Climate Change: The Role of the Green Infrastructure, Built Environment Volume 33 Number 1, 2007
- <sup>80</sup> Benefits of NYC's Urban Forest, Million Trees NYC, [http://www.milliontreesnyc.org/html/urban\\_forest/urban\\_forest\\_benefits.shtml](http://www.milliontreesnyc.org/html/urban_forest/urban_forest_benefits.shtml)
- <sup>81</sup> Valuation of Trees for Amenity and Related Non-Timber Uses Guidance Note, Royal Institution of Chartered Surveyors, 2010
- <sup>82</sup> Trees in towns II: A New Survey of Urban Trees in England and Their Condition and Management, Communities and Local Government, 2008
- <sup>83</sup> Guidelines for the Planning, Installation & Maintenance of Utility Apparatus in Proximity to Trees, National Joint Utilities Group Volume 4, 2007
- <sup>84</sup> A Risk Limitation Strategy for Tree Root Claims 3rd Edition, London Tree Officers Association, 2007
- <sup>85</sup> Managing Urban Trees, Commission for Architecture and Built Environment, <http://www.cabe.org.uk/sustainable-cities/advice/urban-trees>, 2010
- <sup>86</sup> Best Practice Guidelines: How to Assess the Suitability of a Site for Street Tree Planting and What to do Next ,Trees for Cities, 2008
- <sup>87</sup> Tree Roots in the Built Environment, Communities and Local Government, 2006
- <sup>88</sup> BS 5489: 2003, Code of Practice for the Design of Road Lighting – Part 1: Lighting of Roads and Public Amenity Areas, British Standards Institute, 2003
- <sup>89</sup> BS EN 13201-2: 2003, Road Lighting – Performance Requirements, British Standards Institute, 2003
- <sup>90</sup> BS EN 13201-3: 2003, Road Lighting – Calculations of Performance, British Standards Institute, 2003
- <sup>91</sup> BS EN 13201-4: 2003, Road Lighting – Methods of Measuring Lighting Performance, British Standards Institute, 2003
- <sup>92</sup> Guide on the Limitation of the Effects of Obtrusive Light from Outdoor Lighting Installations, International Commission on Illumination, 2003
- <sup>93</sup> Guidelines for Minimising Sky Glow, International Commission on Illumination, 1997
- <sup>94</sup> Guidance Notes for the Reduction of Obtrusive Light, Institution of Lighting Engineers, 2005
- <sup>95</sup> Lighting in the Countryside: Towards Good Practice, Communities and Local Government, 1997
- <sup>96</sup> Working Together to Protect Crowded Places, Home Office, 2010
- <sup>97</sup> Crowded Places: The Planning System and Counter Terrorism, Home Office and Communities and Local Government, 2010
- <sup>98</sup> Protecting Crowded Places: Design and Technical Issues, Home Office, 2010
- <sup>99</sup> Traffic Signs Manual, Department for Transport, Various
- <sup>100</sup> The Suffolk Countryside Manual: Design Guidelines for Highway Works in Rural Areas, Suffolk Local Authorities, 2003
- <sup>101</sup> The Use of Coloured Surfacing in Road Layout, Traffic Safety and Environmental Division, Highways Agency, ETC Proceedings, 1997
- <sup>102</sup> Statutory Guidance to Local Authorities on the Civil Enforcement of Parking Contraventions, Department for Transport, 2008
- <sup>103</sup> Shrewsbury Historic Core Zone. Traffic Advisory Leaflet 8/98, Department for Transport, 1998

## References





# Index

Note: Titles of documents are printed in *italics*.

- Access see Vehicle access
- ADEPT 3
- Advanced cycle stop lines 69
- Alignment of highway 52, 54, 109, 111
- Anti-terrorism measures 94
- Arterial routes 17
- At-grade crossings 16, 57, 62, 116
- Audits
  - quality 34–7
  - road safety 34, 37–8
- Barriers
  - pedestrian 61, 84, 87–91
  - security 94
- Benefits 9, 11
  - case studies 107, 111, 118, 122, 127–8
- Blind people see Visual impairment
- Bollards 87, 96–7
- Boulevards 21
- Building frontages, vehicle access 71
- Buses 49–50
  - bus boarders 50
  - bus ‘gates’ 104
  - bus lanes 49, 104
  - bus laybys 50
  - bus priority systems 49
  - bus routes 49
  - bus stops 49, 49–50
  - carriageway width 49, 53
  - stopping sight distance (SSD) 73–4
- CABE (Commission for Architecture and the Built Environment) 11
- Cambridge, cycle lanes 46
- Car parking see On-street parking
- Carriageways
  - design speed 51–2
  - gradients 52–3
  - horizontal alignment 52, 54
  - vertical curvature 53
  - width 53
    - changes in 59, 64
    - roundabouts 66
    - vehicle lanes 45, 49, 53
    - and vehicle speeds 30, 77
- Case studies 103–28
  - High Row & West Row, Darlington 119–23
  - London Road, Southampton 108–12
  - Maid Marian Way, Nottingham 124–8
  - Sheaf Square & Howard Street, Sheffield 113–18
  - Walworth Road, Southwark, 103–7
- Central islands 66, 96–7
- Central medians/reservations 54–5
- Central refuges 54, 59, 60, 96–7
- Centreline markings 97
- City centres 15–16
  - case studies 113–23
- Classification of streets see Street types
- Coloured road surfacing 95, 98
- Comfort space 28
- Commission for Architecture and the Built Environment (CABE) 3, 11
- Communal space 15, 28, 65
- Community involvement 31–2, 111, 126–7
- Connectivity 17, 21, 22, 63
- Context appraisal
  - interchanges 23
  - rural areas 26
  - town and city centres 15
  - urban and rural settlements 27
  - urban and suburban areas 17
  - urban extensions 21
  - village centres 24
- Corner radii 60, 64, 69
- Crime prevention 94
- Crossing Regulations* 58, 97
- Crossings for pedestrians see Pedestrian crossing points
- Crossovers 64–5
- Curve radii 52, 75
- Cycle lanes 45–6
- Cycle parking 47
- Cycle tracks 46
- Cycling 45–7
  - advanced cycle stop lines 69
  - carriageway/lane width 53
  - cyclists needs 45
  - junction design 63
  - roundabouts 66
  - safety 63, 65, 69, 76
  - shared use footway/cycle space 16, 46, 121
  - traffic management systems 70
  - transport integration 23
  - vehicle forward visibility 76
- Darlington, High Row & West Row 119–23
- DASs (Design and Access Statements) 34
- Design and Access Statements (DASs) 34
- Design audits 34–7
- Design context see Context appraisal
- Design guidance 30
- Design Manual for Roads and Bridges (DMRB)* 4, 8, 51
- Design principles 7–8
- Design process 31–40
- Design quality 34–7
- Design responsibility 30
- Design speed 51–2
- Design standards 4, 8, 30
- Desire lines see Pedestrian desire lines
- Development Team approach 35, 126
- Diagonal crossings 63
- Direct frontage access 8, 64–5, 71, 79

- Direction signs *see* Traffic signs
- Disabled people *see* Mobility impairment; Visual impairment
- DIY Streets 32
- DMRB (*Design Manual for Roads and Bridges*) 4, 8, 51
- Dropped kerbs 28, 55–6
- Echelon parking 81–2, 111
- Energy efficiency 93
- English Heritage
  - Streets For All* 28, 34
  - Suburbs and the Historic Environment* 17
- Footways
  - at bus stops 50
  - obstructions 85–7, 94
  - parking on 89
  - provision 43–4
  - vehicle crossovers 64–5
  - visibility splays 79
  - width 43, 82, 87
    - echelon and right angle parking 82
    - and street furniture 86–7
    - and street trees 92
- Forward visibility 75
- Frontage access 8, 71
- Funding 111, 122, 127
- Ghost islands 64
- Give way signs and marking 98
- Gradients 44, 52–3
- Green infrastructure (*see also* Trees) 11
- Guardrailing 61, 84, 87–91
- Heavy goods vehicles (HGV)
  - carriageway width 53
  - stopping sight distance (SSD) 73–4
- High streets 17–18, 21–3
  - case studies 103–12
  - design context 18
- Highway authorities
  - design responsibility 30
  - Quality Audit (QA) 34
  - Road Safety Audit (RSA) 38
  - street furniture rationalisation 84, 95
- Highway Code* 29
- Highway networks 14
- Highway Risk and Liability Claims* 29, 30
- Historic areas
  - conserving the suburbs 17
  - understanding place 14
  - use of natural materials 28
- Historic features 28, 33
  - kerbstones 56
  - street audits 34
- Horizontal alignment 52, 54, 109, 111
- Hull, Newland Avenue project 44
- Implementation process 31–40
- Improvement stages 32–3
- Informal crossings 59
- Informatory signs *see* Signage
- Integrated transport 23
- Interchanges 22, 47
- Junction design (*see also* Priority junctions; Roundabouts)
  - 57–8, 63–5
  - carriageway width 64
  - corner radii 60, 64, 69
  - cycle safety 63
  - guardrailing 89–90
  - pedestrian crossing points 58–63, 64
  - spacing of junctions 58
  - visibility splays 80
- Keep left/right signs 96–7
- Kent, quality audit process 35
- Kerb build-outs
  - keep left/right signs 96, 97
  - on-street parking 81
  - pedestrian crossing points 59
- Kerbs 28, 55–6
  - bus boarders 50
  - defining staggered crossings 89
  - granite kerbstones 56
  - and visual impairment 121
- Landscaping (*see also* Trees) 11
- Laybys, bus 50
- Left turn lanes 66, 69
- Legal requirements
  - bollards and signs on median islands 97
  - no-entry signs 99
  - pedestrian crossing points 58
  - risk and liability 29–30
  - road markings 98, 99
  - stopping sight distance (SSD) 8, 73–5
  - traffic signs
    - backing boards 70
    - size and height 95–6
- Level surface 28, 55–6
- Liability and risk *see* Risk and liability
- Lighting, street 93–4
- ‘Link and Place’ methodology 13–14
- Local policies and standards 30
- London Borough of Hackney 91
- London Borough of Hounslow 39
- Maintenance issues 38–9
- Manual for Streets* (MfS)
  - principles 7–8
  - scope 8–9
- Materials *see* Surface materials
- Medians 54, 97, 128
- Mini-roundabouts 67–8
- Mixed Priority Routes (MPR) (*see also* Shared space)
  - community involvement 31
  - demonstration projects 10, 44, 89, 103–7
- Mobility impairment (*see also* Wheelchair users)
  - bus boarders 50
  - footway crossovers 65
  - kerb heights 55, 59
- Motor vehicles *see* Vehicle

- Movement function 13–14
  - boulevards 21
  - high streets 18, 22
  - interchanges 23
  - relief/ring roads 19
  - residential streets 22
  - rural roads and lanes 26
  - shared space 28
  - town and city centres 15
  - village centres 24–5
- Movement/place diagram 13–14
- Multifunctional streets and spaces 15
- Networks *see* Highway networks; Pedestrian networks
- New-build schemes 18
- No entry signs 99
- Nottingham, Maid Marian Way 124–8
- Obstructions (*see also* Visibility)
  - on footways 85–7, 94
- On-street parking 81–2
  - echelon and right angle parking 81–2, 111
  - on footways 89
  - in visibility splays 80
  - yellow lines 99
- One-way streets 70–1
- Outcomes 10
  - case studies 107, 111–12, 118, 122–3, 127–8
- Overrunning
  - central median 53
  - footways 89
  - hatched areas 98
- Parking *see* On-street parking
- Partially-sighted people *see* Visual impairment
- Pavement parking 89
- Pavements *see* Footways
- Paving materials (*see also* Tactile paving) 28, 34, 56
- Pedestrian barriers 61, 84, 87–91
- Pedestrian bridges 57
- Pedestrian crossing points 58–63
  - ghost islands 64
  - grade separation 57
  - granite blocks 107
  - mini-roundabouts 68
  - and on-street parking 82
  - roundabouts 66
  - surface level crossings 16, 57, 62, 116
  - tabled crossings 100
- Pedestrian desire lines 58, 59, 60, 66
- Pedestrian Environment Review Software (PERS) 23
- Pedestrian gradients 44
- Pedestrian guardrailling 61, 84, 87–91
- Pedestrian needs 43
- Pedestrian networks 15, 23, 43
- Pedestrian refuges 54, 59, 60, 64
- Pedestrian underpasses 57, 124
- Pedestrianised areas 16
  - case studies 113–23
- Permeable street layouts *see* Connectivity
- PERS (Pedestrian Environment Review Software) 23
- Place function 13–14
  - boulevards 21
  - high streets 18, 22
  - interchanges 23
  - relief/ring roads 19
  - residential streets 22
  - rural roads and lanes 26
  - shared space 28
  - town and city centres 15
  - village centres 24–5
- Place/movement matrix 13–14
- Planning policies 30
- Planting *see* Landscaping; Trees
- Policy context 30
- Priority junctions 63–5
  - signs and markings 98–9
  - visibility 76–8, 80
  - X and Y distances 78
- Public consultation 31–2, 111, 126–7
- Public space 15, 28, 65
- Public squares 65
- Public transport (*see also* Buses)
  - in case studies 104, 110
  - interchanges 23
  - urban extensions 21
- Quality Audit (QA) 34–7
- Raised crossings 59–60
- Refuges 54, 59, 60, 64
- Regulations *see* Design standards; Legal requirements
- Relief roads 18–20
- Residential streets 21–3, 51
- Responsible driving 29
- Right turning lanes 63–4
- Ring roads 18–20, 115
  - case study 124–8
- Risk and liability (*see also* Road safety) 29–30
- Risk assessment 37–8
- Risk compensation 30
- Road markings 95
  - centrelines 97
  - coloured surfacing 95, 98
  - cycle lanes 46
  - for parking 99–100
  - tabled crossings 100
  - zig-zag markings 98
- Road safety (*see also* Risk and liability; Speed reduction)
  - cycling 63, 65, 69, 76
  - in demonstration projects 10, 106, 107, 111, 117, 122, 127
  - direct frontage access 71
  - drivers' responsibility 29
  - guard railing 87–90
  - highway authority's responsibility 30, 38
  - horizontal deflection 65
  - junctions 63, 68, 71, 80
  - pedestrian crossing points 59

- roundabouts 65, 68
  - street furniture removal 84
  - traffic signal junctions 68
  - and visibility 71, 77, 80
- Road Safety Audit (RSA) 34, 37–8
- Road surfacing, coloured see Surface materials
- Road types see Street types
- Roundabouts 65–8, 98
- RSA (Road Safety Audit) 34, 37–8
- Rural roads and lanes 26–7
  - design speed 51
  - signs and road markings 95
- Rural settlements 27–8
- Safety see Road safety
- Safety audits 37–8
- Security measures 94
- Servicing bays 82
- Shared space
  - benefits 9, 11
  - definition 28
  - design issues 28
  - Manual for Streets* principles 7–8
  - typical characteristics 27–8
- Shared use footway/cycle space 16, 46, 121
- Sheffield, Sheaf Square & Howard Street 113–18
- Sight distance see Stopping sight distance (SSD)
- Signage (see also Traffic signs)
  - ‘de-cluttering’ 83–7
- Signalised crossings 59, 61
- Single lane working 70–1
- Solihul, quality audit process 36
- Southampton, London Road 108–12
- Speed limits 51–2
- Speed reduction
  - horizontal alignment 52, 54
  - at junctions 63, 64
  - speed tables 63, 100
  - vertical curvature 53
- Squares 65
- SSD (Stopping sight distance) 8, 73–5
- Staged approach 32–3
- Staggered crossings 61, 89, 112
- Standards see Design standards
- Stopping sight distance (SSD) 8, 73–5
- Straight ahead crossings 60–2
- Street audits 23, 34
- Street character assessments 34
- Street furniture 83–91, 125
  - audits 34
  - ‘footprint in use’ 86
  - reducing ‘clutter’ 83–7
- Street lighting 93–4
- Street networks 14, 17, 23, 43
- Street trees 91–3
- Street types 13
  - arterial routes 17
  - boulevards 21
  - high streets 17, 21
  - multifunctional streets and spaces 15
  - relief road/ring road 18–19
  - residential streets 21
  - rural roads and lanes 26
  - shared space 27–8
  - village streets 24
- Streets For All* 28, 34
- Suburban areas 17–21
- Suburbs and the Historic Environment* 17
- Subways see Underpasses
- Surface level crossings 16, 57, 62, 116
- Surface materials
  - coloured road surfacing 95, 98
  - paving materials 28, 34, 56
  - pedestrian crossing points 107
- Surveillance 34
- Sustainability 9, 21, 93
- Sustrans DIY Streets project 32
- Tabled crossings 63, 100
- Tactile paving 28, 58
- Town centres 15–16
- Traffic management systems 70–1, 83
- Traffic signals 68–70
- Traffic signs 95–7
  - at junctions 98–9
  - keep left/right signs 96–7
  - reducing ‘clutter’ 83–7
  - size and mounting height 95–6
  - yellow backing boards 96
- Traffic Signs Manual* (TSM) 95
- Traffic Signs Regulations and General Directions* (TSRGD) 95
- Traffic speeds see Vehicle speeds
- Transport for London (TfL)
  - Streetscape Guidance* 85
  - Walking Good Practice* 23
- Transport integration 23
- Trees (see also Landscaping) 91–3, 128
- ‘Trief’ kerbs 56
- Types of streets see Street types
- Uncontrolled crossings 59
- Uncontrolled junctions 63–5
- Underpasses, pedestrian 57, 124
- Urban areas (see also City centres; Suburban areas)
  - context 17–21
  - design speed 51–2
- Urban extensions 21–3
- Urban settlements 27–8
- Vehicle access
  - direct frontage access 8, 64–5, 71, 79
  - restrictions 16

- Vehicle braking 73–4
- Vehicle crossovers 64–5
- Vehicle-lane width 45, 49, 53
- Vehicle speeds (see also Speed reduction)
  - and carriageway width 30, 77
  - design speed 51–2
- Vertical curvature 53
- Village centres 24
- Village gateways 95
- Village streets 24
- Visibility (see also Stopping sight distance (SSD)) 75–80
  - along the street edge 79
  - forward visibility 75
  - at junctions 76–7, 80
  - and vehicle speeds 52
  - visibility splays 79, 80
- Visual impairment
  - bollard height 87
  - kerb loss 121
  - raised tables 111
  - signalised crossings 59
- Walking (see also Pedestrian) 43–4
- Wheelchair users
  - central reservations/medians and refuges 54
  - footway crossovers 65
  - maximum gradient 44
- Width
  - bus boarders 50
  - carriageways
    - changes in 59, 64
    - junctions 64
    - roundabouts 66
    - vehicle lanes 45, 49, 53
  - central reservations/medians and refuges 54
  - cycle lanes 45
  - footways 43, 82, 87
    - echelon and right angle parking 82
    - and street furniture 86–7
    - and street trees 92
  - informal crossings 59
- Yellow lines 99
- Zebra crossings 59
- Zig-zag markings 98





Department for  
**Transport**



**Phil Jones Associates**  
Transport Planning Consultants

